

G-FIRE Figure 579 Grooved Rigid Coupling 1 1/4 Inch to 8 Inch (DN32 to DN200)

General Description

The GRINNELL G-FIRE Figure 579 Grooved Rigid Couplings provide a rigid joint by firmly gripping along the full circumference of the pipe grooves. Figure 579 couplings are a dependable method of joining pipe and are an economical alternative to welding, threading, or using flanges.

Figure 579 couplings are rated at pressures up to 365 psi (25,2 bar) depending on pipe size and wall thickness when used in fire protection service applications. See Table A.

NOTICE

The GRINNELL G-FIRE Figure 579 Grooved Rigid Coupling described herein must be installed and maintained in compliance with this document, as well as with the applicable standards of the Approval agency, in addition to the standards of any other authorities having jurisdiction. Failure to do so may result in serious personal injury or impair the performance of these devices.

Never remove any piping component nor correct or modify any piping deficiencies without first de-pressurizing and draining the system. Failure to do so may result in serious personal injury, property damage, and/or impaired device performance.

It is the designer's responsibility to select products suitable for the intended service and to ensure that pressure ratings and performance data are not exceeded. Material and gasket selection should be verified to be compatible for the specific application. Always read and understand the installation instructions.

IMPORTANT

Refer to Technical Data Sheet TFP2300 for warnings pertaining to regulatory and health information.

The owner is responsible for maintaining their mechanical system and devices in proper operating condition. Contact the installing contractor or device manufacturer with any questions.

Technical Data

Approvals

UL and ULC Listed
FM Approved
VdS Approved
LPCB Certified

See Table A for details.

Sizes

1 1/4 in. to 8 in. (DN32 to DN200)

Housing

Ductile iron conforming to ASTM A536, Grade 65-45-12

Finish

- Orange non-lead paint
- Red non-lead paint
- Hot-dipped, Galvanized conforming to ASTM A153

Bolt/Nut

- ANSI:
Carbon Steel oval neck track head bolts are heat-treated and conform to the physical properties of ASTM A183 Grade 2 and SAE J429 Grade 5 with a minimum tensile strength of 110,000 psi.

Carbon Steel heavy hex nuts conform to the physical properties of ASTM A183 Grade 2 and SAE J995 Grade 5. Bolts and nuts are zinc-electroplated conforming to ASTM B633.

- Metric:
Carbon Steel oval neck track head bolts (Gold color coded) are heat-treated and conform to the physical properties of ASTM F568M with a minimum tensile strength of 760 MPa.

Carbon Steel heavy hex nuts conform to the physical properties of ASTM A563M Class 9. Bolts and nuts are zinc-electroplated conforming to ASTM B633.

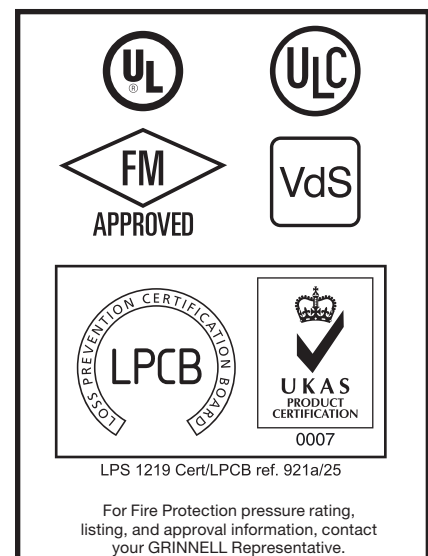
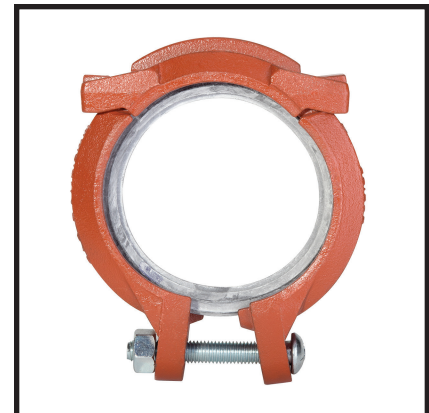

Gaskets

- Pre-lubricated Grade "A" EPDM, Violet color code, -30°F to 150°F (-34°C to 66°C)

For dry and freezer systems, lubrication is required. Refer to Installation Manual IH-1000FP for details.

For proper gasket selection, refer to Technical Data Sheet TFP1895.

Pipe Size		Max. ^b Pressures psi (bar)	Max. ^b End Load Lbs. (kN)	Max. ^{a, c} End Gap Inches (mm)	Nominal Dimensions						Coupling Bolts		Approx. Weight Lbs. (kg)
Nominal ANSI Inches DN	O.D. Inches (mm)				A (Open) Inches (mm)	A (Closed) Inches (mm)	B (Radius) Inches (mm)	C (Radius) Inches (mm)	D (Radius) Inches (mm)	E Inches (mm)	Qty.	Size ^d Inches (mm)	
1 1/4 32	1.660 (42,4)	365 (25,2)	790 (3,51)	0.32 (8,1)	3.05 (77,5)	2.81 (71,4)	2.53 (64,3)	2.88 (73,2)	2.06 (52,3)	2.05 (51,9)	1	3/8 x 2 1/2 (M10 x 64)	1.7 (0,8)
1 1/2 40	1.900 (48,3)	365 (25,2)	1035 (4,60)	0.32 (8,1)	3.36 (85,3)	3.08 (78,2)	2.70 (68,6)	2.98 (75,7)	2.19 (55,6)	2.05 (51,9)	1	3/8 x 2 1/2 (M10 x 64)	1.8 (0,8)
2 50	2.375 (60,3)	365 (25,2)	1617 (7,19)	0.32 (8,1)	3.92 (99,6)	3.41 (86,5)	2.94 (74,7)	3.36 (85,2)	2.40 (60,8)	2.05 (51,9)	1	3/8 x 2 3/4 (M10 x 70)	1.9 (0,9)
2 1/2 65	2.875 (73,0)	365 (25,2)	2370 (10,54)	0.32 (8,1)	4.48 (113,8)	3.97 (100,7)	3.19 (81,1)	3.54 (90,0)	2.64 (67,2)	2.05 (51,9)	1	3/8 x 2 3/4 (M10 x 70)	2.1 (1,0)
76,1 65	3.000 (76,1)	350 (24,1)	2474 (11,00)	0.32 (8,1)	4.53 (115,1)	4.09 (103,9)	3.24 (82,2)	3.59 (91,2)	2.69 (68,3)	2.05 (51,9)	1	3/8 x 2 3/4 (M10 x 70)	2.2 (1,0)
3 80	3.500 (88,9)	365 (25,2)	3512 (15,62)	0.32 (8,1)	5.10 (129,5)	4.57 (116,0)	3.45 (87,7)	3.79 (96,2)	3.18 (80,7)	2.05 (51,9)	1	3/8 x 2 3/4 (M10 x 70)	2.8 (1,3)
4 100	4.500 (114,3)	365 (25,2)	5805 (25,82)	0.32 (8,1)	6.20 (157,5)	5.67 (143,9)	4.32 (109,7)	4.71 (119,6)	3.70 (93,9)	2.05 (51,9)	1	1/2 x 3 1/2 (M12 x 89)	4.0 (1,8)
139,7 125	5.500 (139,7)	300 (20,7)	7127 (31,70)	0.32 (8,1)	7.63 (193,9)	7.14 (181,3)	4.92 (125,0)	5.18 (131,5)	4.37 (111,1)	2.05 (51,9)	1	1/2 x 3 1/2 (M12 x 89)	5.9 (2,7)
165,1 150	6.500 (165,1)	300 (20,7)	9955 (44,28)	0.32 (8,1)	8.67 (220,2)	8.14 (206,6)	5.39 (137,0)	5.60 (142,2)	4.85 (123,3)	2.05 (51,9)	1	1/2 x 3 1/2 (M12 x 89)	6.7 (3,0)
6 150	6.625 (168,3)	365 (25,2)	12582 (55,97)	0.32 (8,1)	8.85 (224,8)	8.26 (209,8)	5.50 (139,6)	5.65 (143,6)	4.93 (125,2)	2.05 (51,9)	1	1/2 x 3 1/2 (M12 x 89)	6.7 (3,0)
8 200	8.625 (219,1)	365 (25,2)	21326 (94,86)	0.34 (8,6)	11.62 (295,1)	10.77 (273,5)	7.06 (179,4)	7.29 (185,2)	6.49 (164,9)	2.59 (65,8)	1	5/8 x 4 1/8 (M16 x 105)	14.2 (6,4)

Note:

- a. Maximum available gap between pipe ends. Minimum gap = 0.120 in. (3,05 mm)
- b. Maximum Pressure and End Load are total from all loads based on standard weight steel pipe. Pressure ratings and end loads may differ for other pipe materials and/or wall thickness. Contact your GRINNELL Representative.
- c. Max End Gap is for cut grooved standard weight pipe.
- d. Gold color coded metric bolts and nuts are available upon request.

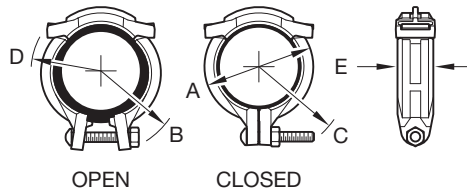

FIGURE 1
G-FIRE FIGURE 579 GROOVED RIGID COUPLING, 1 1/4 INCH TO 8 INCH (DN32 TO DN200)
NOMINAL DIMENSIONS

Pipe Sizes ^c Nominal ANSI Inches (O.D. mm)	Pipe Schedule ^b	Pressure Rating psi (bar)		
		UL	ULC	FM
1 1/4 (42,4); 1 1/2 (48,3); 2 (60,3)	10	365 (25,2)	365 (25,2)	365 (25,2)
	40	365 (25,2)	365 (25,2)	365 (25,2)
2 1/2 (73,0); 3 (88,9); 4 (114,3)	10	350 (24,1)	350 (24,1)	365 (25,2)
	40	365 (25,2)	365 (25,2)	365 (25,2)
6 (168,3); 8 (219,1) ^a	10	300 (20,7)	300 (20,7)	300 (20,7)
	40	365 (25,2)	365 (25,2)	365 (25,2)

Pipe O.D. ^c mm	Pipe Specification ^b	Pressure Rating psi (bar)	
		UL	FM
76,1	ISO 4200 Type F	300 (20,7)	350 (24,1)
	ISO 4200 Type E	300 (20,7)	300 (20,7)
	ISO 4200 Type D	300 (20,7)	—
	EN 10255 Heavy	—	300 (20,7)
	EN 10255 Medium	300 (20,7)	300 (20,7)
139,7	ISO 4200 Type D, E, and F	300 (20,7)	300 (20,7)
	EN 10255 Heavy	—	300 (20,7)
	EN 10255 Medium	—	300 (20,7)
165,1	EN 10255 Heavy	—	300 (20,7)
	EN 10255 Medium	300 (20,7)	300 (20,7)

Pipe Sizes Nominal ANSI Inches (O.D. mm)	Pipe Specification ^d	Pressure Rating psi (bar)	
		LPCB	VdS
1 1/4 (42,4); 1 1/2 (48,3); 2 (60,3); — (76,1); 3 (88,9); 4 (114,3); — (165,1)	ISO 65 Medium	290 (20)	—
6 (168,3); 8 (219,1)	ISO 4200 Wall Thickness 5,4 mm	290 (20)	—
1 1/4 (42,4); 1 1/2 (48,3); 2 (60,3); — (76,1); 3 (88,9); 4 (114,3); — (139,7); 6 (168,3)	DIN 2448 or 2458	—	232 (16)

Note:

- a. For 8 in. (219,1 mm) size, minimum allowed pipe wall thickness is 0.188 in. (4,77 mm).
- b. See Agency website for Listing/Approvals of specialty pipe:
 UL website - see Online Certification Directory, www.ul.com
 FM Global website - www.approvalguide.com
- c. All couplings approved for dry pipe systems
- d. See Agency website for Listing/Approvals of other pipe specifications:
 LPCB website - See Search Our Listings - Automatic Sprinklers, Water Spray and Deluge Systems, www.redbooklive.com
 VdS website - see certifications, www.vds.de

TABLE A
LISTED/APPROVED PRESSURE RATINGS

Installation

GRINNELL G-FIRE Figure 579 Grooved Rigid Coupling must be installed in accordance with this section.

General Instructions

Always read and understand the instructions. Never remove any piping component without verifying that the system is depressurized and drained.

The Figure 579 Grooved Rigid Coupling with additional lubrication is recommended for applications below 40°F (4°C).

The installation is based on pipe grooved in accordance with Standard Cut Groove or Roll Groove Specifications. Refer to Technical Data Sheet TFP1898 for additional information.



Step 1. Inspect exterior groove and ends of the pipe to verify all burrs, loose debris, dirt, chips, paint and any other foreign material such as grease are removed. Pipe end sealing surfaces must be free from sharp edges, projections, indentations, and/or other defects.

Grade "A" gaskets are supplied with a pre-lubricant and do not require additional lubrication for applications above 40°F (4°C).

NOTE: Additional lubrication must be used in dry pipe and freezer applications. A silicone based lubricant is recommended.

To prevent deterioration of the gasket material a petroleum lubricant should not be used on Grade "A" "EPDM".

CAUTION

Removal of the nut from the bolt may result in the coupling segments separating at the hinges and the coupling disengaging from the pipe. Use caution to avoid equipment damage and/or personal injury.



Step 2. Do not remove the nut from the bolt. Open the coupling by extending the coupling segments out to the extent allowed by the bolt and nut.



Step 3. Push the gasket/coupling onto one end of the pipe until the center-stop of the gasket is in contact with the end of the pipe (See Figure 2).

NOTE: The gasket center-stop should not ride up onto the gasket sealing surface (See Figure 2).

CAUTION

Do not leave coupling unattended on a single pipe end as it may disengage from the pipe. Failure to do so may result in equipment damage and/or personal injury.

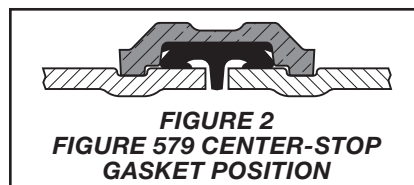

Step 4. Slide the other pipe end into the gasket/coupling ensuring that it makes contact with the center stop of the gasket (See Figure 2). Both pipes should be aligned vertically and horizontally. Verify that the housing is over the gasket and that the housing keys are aligned with the pipe grooves.



Step 5. Tighten nut to the recommended bolt torque (See Figure 4). Visually inspect the coupling to ensure that the housing keys are engaged into the pipe grooves.

NOTICE

The 1 1/4 in. to 8 in. (DN32 to DN200) couplings have an intended gap of up to 1/16 in. (1,60 mm) at the bolt pad to allow for positive rigid gripping onto the pipe.

Bolt-torque information is supplied as a guideline and may be used when setting the torque on power impact wrenches. Refer to the manufacturer's instructions for settings.

Bolt lengths require the use of deep or extra-deep-well sockets. Sockets inner depth information is supplied for reference only. (See Figure 4) For specific socket recommendations, contact Technical Services.

Nominal Pipe Size ANSI Inches DN	Pipe O.D. Inches (mm)		A ±0.031 (±0.78) Inches (mm)	B ±0.031 (±0.78) Inches (mm)	C Groove Diameter Inches/mm		D Nominal Groove Depth Inches (mm)	T Minimum Wall Inches (mm)	Maximum Allow Flare Diameter Inches (mm)	
	O.D. Inches (mm)	Tolerance			Actual	Tol. +0.000				
		+								-
1 1/4 (32)	1.660 (42,4)	0.029 (0,74)	0.016 (0,41)	0.625 (15,88)	0.281 (7,14)	1.535 (38,99)	-0.015 (-0,38)	0.063 (1,60)	0.065 (1,65)	1.77 (44,96)
1 1/2 (40)	1.900 (48,3)	0.019 (0,48)	0.019 (0,48)	0.625 (15,88)	0.281 (7,14)	1.775 (45,09)	-0.015 (-0,38)	0.063 (1,60)	0.065 (1,65)	2.01 (51,05)
2 50	2.375 (60,3)	0.024 (0,61)	0.024 (0,61)	0.625 (15,88)	0.344 (8,74)	2.250 (57,15)	-0.015 (-0,38)	0.062 (1,60)	0.065 (1,65)	2.48 (62,99)
2 1/2 65	2.875 (73,0)	0.029 (0,74)	0.029 (0,74)	0.625 (15,88)	0.344 (8,74)	2.720 (69,09)	-0.018 (-0,46)	0.078 (1,98)	0.083 (2,11)	2.98 (75,69)
76,1mm (65)	3.000 (76,2)	0.030 (0,76)	0.030 (0,76)	0.625 (15,88)	0.344 (8,74)	2.845 (72,26)	-0.018 (-0,46)	0.076 (1,93)	0.083 (2,11)	3.10 (78,74)
3 80	3.500 (88,9)	0.035 (0,89)	0.031 (0,79)	0.625 (15,88)	0.344 (8,74)	3.344 (84,94)	-0.018 (-0,46)	0.078 (1,98)	0.083 (2,11)	3.60 (91,44)
4 100	4.500 (114,3)	0.045 (1,14)	0.031 (0,79)	0.625 (15,88)	0.344 (8,74)	4.334 (110,08)	-0.020 (-0,51)	0.083 (2,11)	0.083 (2,11)	4.60 (116,84)
139,7mm (125)	5.500 (139,7)	0.056 (1,42)	0.031 (0,79)	0.625 (15,88)	0.344 (8,74)	5.334 (135,48)	-0.022 (-0,56)	0.083 (2,11)	0.109 (2,77)	5.60 (142,24)
165,1mm (150)	6.500 (165,1)	0.063 (1,60)	0.031 (0,79)	0.625 (15,88)	0.344 (8,74)	6.330 (160,78)	-0.022 (-0,56)	0.085 (2,16)	0.109 (2,77)	6.60 (167,64)
6 150	6.625 (168,3)	0.063 (1,60)	0.031 (0,79)	0.625 (15,88)	0.344 (8,74)	6.455 (163,96)	-0.022 (-0,56)	0.085 (2,16)	0.109 (2,77)	6.73 (170,94)
8 200	8.625 (219,1)	0.063 (1,60)	0.031 (0,79)	0.750 (19,05)	0.469 (11,91)	8.441 (214,40)	-0.025 (-0,64)	0.092 (2,34)	0.109 (2,77)	8.80 (223,52)

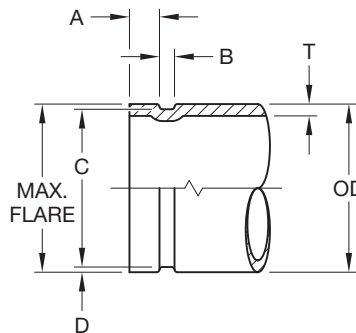

*Swage grooves must be factory produced by Wheatland Tube Co. and meet standard roll groove dimensions. Swage grooves are UL Listed only. See Online Certifications Directory at www.UL.com for details.

FIGURE 3
STANDARD SPECIFICATION
ROLL GROOVE AND SWAGE GROOVE*
STEEL PIPE

Bolt Size ANSI Inches (mm)	Socket Size ANSI Inches (mm)	Inner Minimum Socket Depth Inches (mm)	Bolt Torque Range lb-ft (N-m)
3/8 (M10)	11/16 (17)	2.00 (51)	30-40 (60)
1/2 (M12)	7/8 (22)	2.40 (61)	90-110 (120-150)
5/8 (M16)	1 1/16 (27)	3.00 (76)	130-160 (175-215)

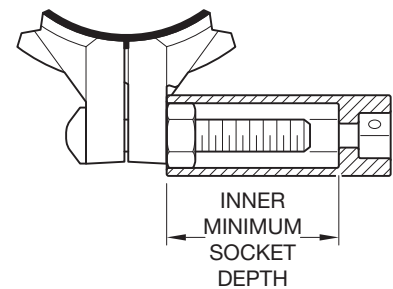

FIGURE 4
BOLT TORQUE AND SOCKET SIZE
RECOMMENDATIONS

Nominal Pipe Size ANSI Inches DN	Pipe O.D. Inches (mm)			A ±0.031 (±0.78) Inches (mm)	B ±0.031 (±0.78) Inches (mm)	C Groove Diameter Inches/mm		D Nominal Groove Depth Inches (mm)	T Minimum Wall Inches (mm)
	O.D. Inches (mm)	Tolerance				Actual	Tol. +0.000		
		+	-						
1 1/4 (32)	1.660 (42,4)	0.029 (0,74)	0.016 (0,41)	0.625 (15,88)	0.313 (7,95)	1.535 (38,99)	-0.015 (-0,38)	0.063 (1,60)	0.140 (3,56)
1 1/2 (40)	1.900 (48,3)	0.019 (0,48)	0.019 (0,48)	0.625 (15,88)	0.313 (7,95)	1.775 (45,09)	-0.015 (-0,38)	0.063 (1,60)	0.145 (3,68)
2 50	2.375 (60,3)	0.024 (0,61)	0.024 (0,61)	0.625 (15,88)	0.313 (7,95)	2.250 (57,15)	-0.015 (-0,38)	0.062 (1,60)	0.154 (3,91)
2 1/2 65	2.875 (73,0)	0.029 (0,74)	0.029 (0,74)	0.625 (15,88)	0.313 (7,95)	2.720 (69,09)	-0.018 (-0,46)	0.078 (1,98)	0.188 (4,78)
76,1mm (65)	3.000 (76,2)	0.030 (0,76)	0.030 (0,76)	0.625 (15,88)	0.313 (7,95)	2.845 (72,26)	-0.018 (-0,46)	0.076 (1,93)	0.188 (4,78)
3 80	3.500 (88,9)	0.035 (0,89)	0.031 (0,79)	0.625 (15,88)	0.313 (7,95)	3.344 (84,94)	-0.018 (-0,46)	0.078 (1,98)	0.188 (4,78)
4 100	4.500 (114,3)	0.045 (1,14)	0.031 (0,79)	0.625 (15,88)	0.375 (9,53)	4.334 (110,08)	-0.020 (-0,51)	0.083 (2,11)	0.203 (5,16)
139,7mm (125)	5.500 (139,7)	0.056 (1,42)	0.031 (0,79)	0.625 (15,88)	0.375 (9,53)	5.334 (135,48)	-0.022 (-0,56)	0.083 (2,11)	0.203 (5,16)
165,1mm (150)	6.500 (165,1)	0.063 (1,60)	0.031 (0,79)	0.625 (15,88)	0.375 (9,53)	6.330 (160,78)	-0.022 (-0,56)	0.085 (2,16)	0.219 (5,56)
6 150	6.625 (168,3)	0.063 (1,60)	0.031 (0,79)	0.625 (15,88)	0.375 (9,53)	6.455 (163,96)	-0.022 (-0,56)	0.085 (2,16)	0.219 (5,56)
8 200	8.625 (219,1)	0.063 (1,60)	0.031 (0,79)	0.750 (19,05)	0.438 (11,13)	8.441 (214,40)	-0.025 (-0,64)	0.092 (2,34)	0.238 (6,05)

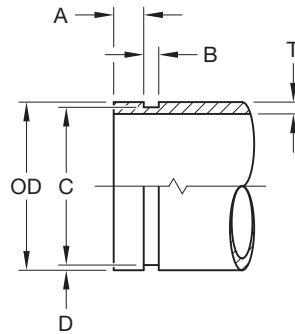

FIGURE 5
STANDARD SPECIFICATION
CUT GROOVE STEEL PIPE

Care and Maintenance

The GRINNELL G-FIRE Figure 579 Grooved Rigid Coupling must be maintained in accordance with this section.

Before closing a fire protection system main control valve for maintenance work on the fire protection system that it controls, obtain permission to shut down the affected fire protection system from the proper authorities and notify all personnel who may be affected by this decision.

After placing a fire protection system in service, notify the proper authorities and advise those responsible for monitoring proprietary and/or central station alarms.

The owner is responsible for the inspection, testing, and maintenance of their fire protection system and devices in compliance with this document, as well as with the applicable standards of the NATIONAL FIRE PROTECTION ASSOCIATION (NFPA), such as NFPA 25, in addition to the standards of any authority having jurisdiction. Contact the installing contractor or product manufacturer with any questions. Any impairments must be immediately corrected.

Automatic sprinkler systems are recommended to be inspected, tested, and maintained by a qualified Inspection Service in accordance with local

requirements and/or national codes.

Limited Warranty

For warranty terms and conditions, visit

www.tyco-fire.com.

Ordering Procedure

GRINNELL Products are available globally through a network of distribution centers. For the nearest distributor, visit www.tyco-fire.com. When placing an order, indicate the full product name.

Specify: G-FIRE Figure 579 Grooved Rigid Coupling, quantity, pipe size (Nominal ANSI or O.D.), finish (Orange, Red, or Galvanized), and Pre-lubricated Grade "A" EPDM gasket.

