

# SR24

## 24" Short Riser Extension System Technical Data

Specifications | Special Precautions | Installation

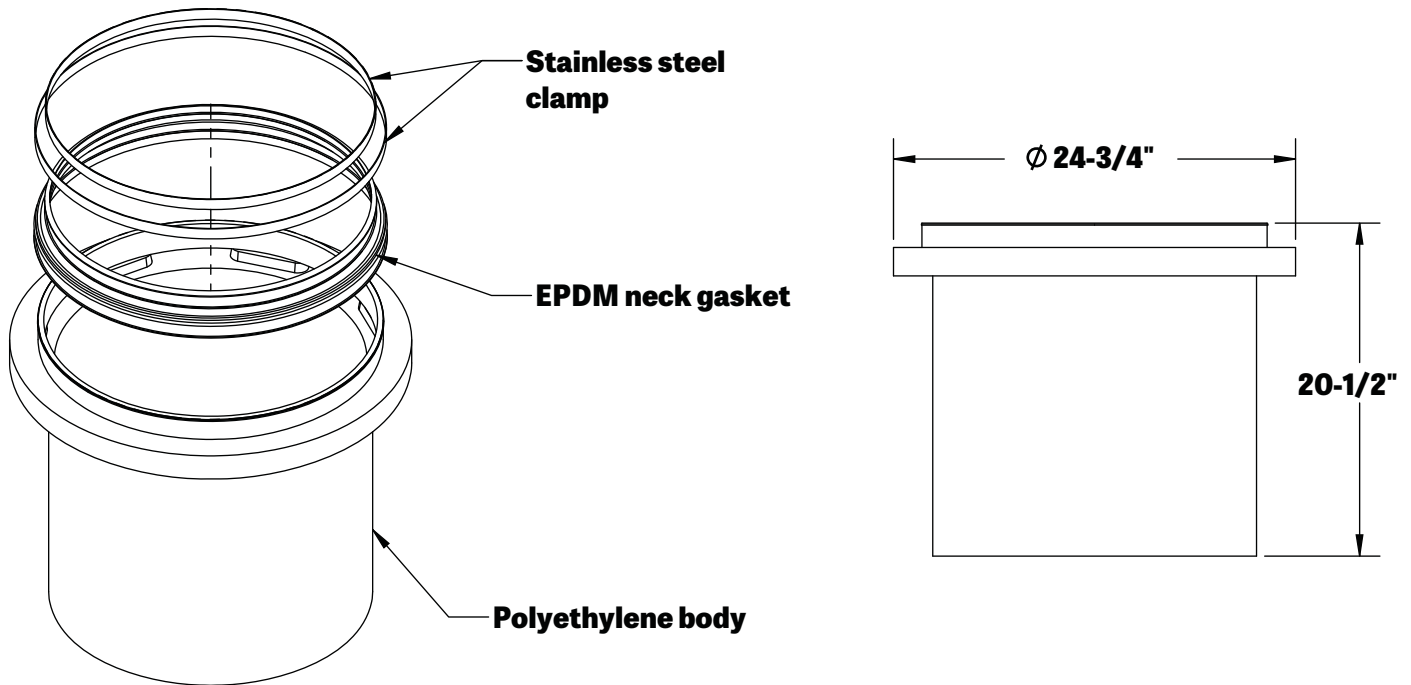

## SPECIFICATIONS

### NOTES:

1. Molded polyethylene body
2. EPDM neck gasket
3. Stainless steel clamps

### ENGINEER SPECIFICATION GUIDE:

TeleGlide field adjustable riser system to consist of rotationally molded polyethylene body, EPDM gasket and stainless steel clamps. Risers shall allow onsite adjustability of cover to grade.



**SCHIER**  
LIFETIME GUARANTEED  
GREASE INTERCEPTORS

MODEL NUMBER:  
**SR24**

DESCRIPTION: 24" Short Riser Extension System

PART #: 8010-002-01

DWG BY: C. O'Boyle

DATE: 4/10/2019

REV: 0 \_\_/\_\_/201\_

ECO:



# SPECIAL PRECAUTIONS

For All Schier Grease Interceptor Installations - Failure to follow this guidance voids your warranty

## Installation Instructions

Installation instructions and additional components are included with the interceptor. Read all instructions prior to installation. This interceptor is intended to be installed by a licensed plumber in conformance with all local codes.

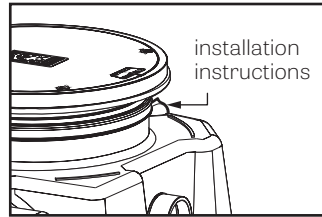

## When Installing Interceptor Inside

If your dishwashing sink(s) discharges into a floor drain/sink (drain), you must regulate the flow into the drain to avoid an overflow of water onto the kitchen floor. This can be done by installing a valve or flow restriction cap on the sink piping that discharges into the drain. See drawing above for guidance. For detailed guidance on indirect connections, go to:

[http://webtools.schierproducts.com/Technical\\_Data/Indirect\\_Connections.pdf](http://webtools.schierproducts.com/Technical_Data/Indirect_Connections.pdf)

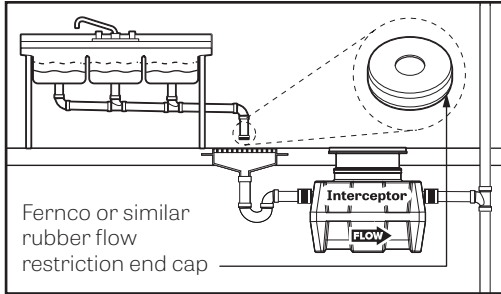

## Hydrostatic Slabs (or Pressure Slabs)

When installed under a hydrostatic slab (slab designed to withstand upward lift, usually caused by hydrostatic pressure) interceptor must be enclosed in a watertight concrete vault.

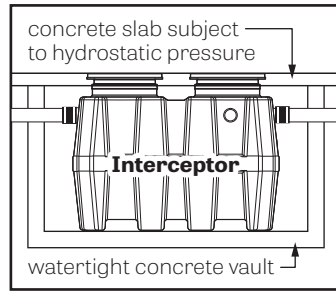

## High Water Table Installations

Interceptors and risers are not designed to withstand water table height in excess of the top of the unit when buried (see figure). If it is possible for this to occur, install the interceptor and risers in a water-tight concrete vault or backfill with concrete or flowable fill (wet concrete and flowable backfill should be poured in stages to avoid crushing the interceptor). At risk areas include but are not limited to tidal surge areas, floodplains and areas that receive storm water.

Models GB-50, GB-75, and GB-250 that are direct buried in high water table scenarios must be installed with model AK1 anchor kit.

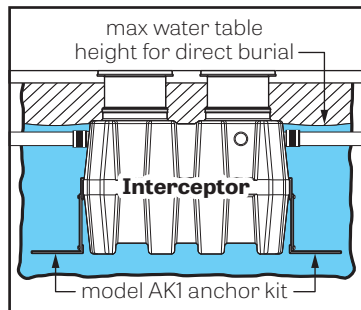

## High Temperature Kitchen Water

If water is entering the interceptor at excessive temperature (over 150° F), a drain water tempering valve (DTV) and approved backflow prevention assembly must be installed. Most state and local plumbing codes prohibit water above 150° F being discharged into the sanitary sewer. Water above 150° F will weaken or deform PVC Schedule 40 pipe, poly drainage fixtures like interceptors and erode the coating of cast iron (leading to eventual failure).

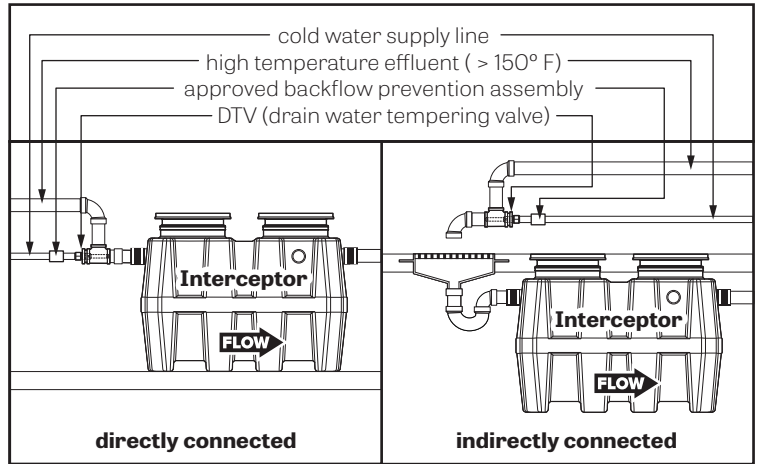

## Fully Support Base of Unit

Install unit on solid, level surface in contact with the entire footprint of unit base; for suspended installations design trapeze to support the wet weight of the unit. Do not partially support unit or suspend unit using metal U-channel to create a trapeze

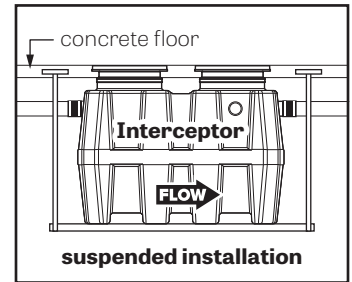

## Support Inlet and Outlet Piping

For above grade installations ensure heavy inlet and outlet piping (such as cast iron or long runs) is properly supported or suspended during the entire installation process to prevent connection failure or damage to bulkhead fittings.

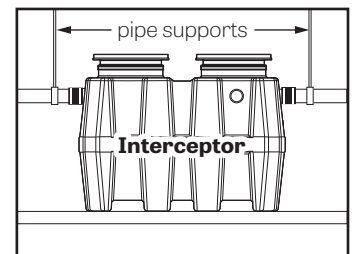

**SCHIER**  
LIFETIME GUARANTEED  
GREASE INTERCEPTORS

MODEL NUMBER:  
**SR24**

DESCRIPTION: 24" Short Riser Extension System

PART #: 8010-002-01

DWG BY: C. O'Boyle

DATE: 4/10/2019

REV: 0 \_\_\_/\_\_\_/201\_

ECO:

# INSTALLATION (1 of 1)

## FIELD CUT RISER (24 SERIES) INSTALLATION GUIDELINES

**Tools needed:** 7/16" Nut driver tool/bit (included), marker (included), tape measure and drill with 1/2" chuck. Jigsaw, circular saw or reciprocating saw will be needed if risers need to be cut.

**NOTE:** To remove a component or adjust its position, the Upper Band Clamp needs to be loosened or removed using nut driver bit. **The Lower Band Clamp is factory set and should not be removed.** For proper fastening ensure clamps are tightened to 5 - 8 ft lbs. of torque (same as a rubber no-hub coupling) prior to installation.

### Riser Assembly Instructions/Steps

1. Set unit so the pipe connections line up with job site piping and measure riser height needed from top of cover to finished grade. See Tables 1-A, 1-B, 1-C and 1-D to select risers needed.
2. Remove covers from adapters. Remove adapters from main unit. On a level surface, pre-assemble the risers and adapters, adjusting the components upwards or downwards to achieve the riser height needed. Make sure to maintain minimum and maximum insertion depths as shown in Figure 2. If components are too long, make a circular line around the sidewall with marker and cut with a power saw. The lowest cut line on the riser assembly will be 6" beyond the riser height needed to allow for ideal insertion depth (See Figure 1). An alignment mark should be drawn 2" beyond the riser height needed which will align with the top of the base unit gasket. **DO NOT** cut the alignment mark. The Adapters and risers should sit level with each other. Tighten upper clamps to keep riser/adaptor assembly from shifting. Make alignment marks on the sidewalls at the top of all riser gaskets to aid final assembly.

3. **IMPORTANT:** Before the next step, for grease interceptor installations, make sure both diffusers are installed inside the main unit at the appropriate locations. Check if there needs to be any flow control adjustment at the inlet diffuser (see general installation instructions).
4. Take apart riser assembly and clean all sidewalls and insides of gaskets to remove dust/debris. Install components into the main units starting from the lowest riser and work your way up to finished grade. Ensure that riser will not interfere with diffuser, allow min. 1" clearance. Maintain minimum and maximum insertion depths for all components (see Figure 2). Tighten Upper Clamps to specified torque after correctly positioning components. Riser assembly may need to be supported during backfill.
5. If tilting of the adapter is required to be flush with grade, do so **AFTER** all clamps have been tightened with riser(s)/adapter in a vertical and level position. Tilting is done using gasket flexibility. Tilting before tightening clamps may ruin a perfect gasket seal. Schier recommends tilting only the adapter versus the entire riser assembly to make sure your riser height and proper tank access is maintained.
6. If riser height conditions change after completing above steps, there may be room for adjustment. As long as minimum and maximum insertion depths are maintained (see Figure 2), the adapters/risers can be adjusted/cut as many times as necessary. When riser system installation is complete, see Leak/Seal Testing procedure if required.



**Table 1-A (GB-50)**

Riser Height Needed	Risers Required
0 - 3-1/2"	None (use adapter)
5" - 23"	SR24
>23" - 38"	LR24

**Table 1-B (GB-75)**

Riser Height Needed	Risers Required
0 - 3-1/2"	None (use adapter)
5" - 23"	SR24
>23" - 38"	LR24
>38" - 43"	SR24 (x2)
>43" - 58"	SR24 + LR24
>58" - 72"	LR24 (x2)

**Table 1-C (GB-250, GB-1000, GGI-750, GGI-1500)**

Riser Height Needed	Risers Required
0 - 3-1/2"	None (use adapter)
5" - 23"	SR24 (x2)
>23" - 38"	LR24 (x2)
>38" - 43"	SR24 (x4)
>43" - 58"	SR24 (x2) + LR24 (x2)
>58" - 72"	LR24 (x4)

**Table 1-D (SV24, FS-DUO, FS-TRIO, FS-QUAD)**

Riser Height Needed	Risers Required
0" - 3"	None (use adapter)
4-1/2" - 23"	SR24
>23" - 37-3/4"	LR24
>37-3/4" - 42-1/2"	SR24 (x2)
>42-1/2" - 57-1/2"	SR24 + LR24
>57-1/2" - 72"	LR24 (x2)

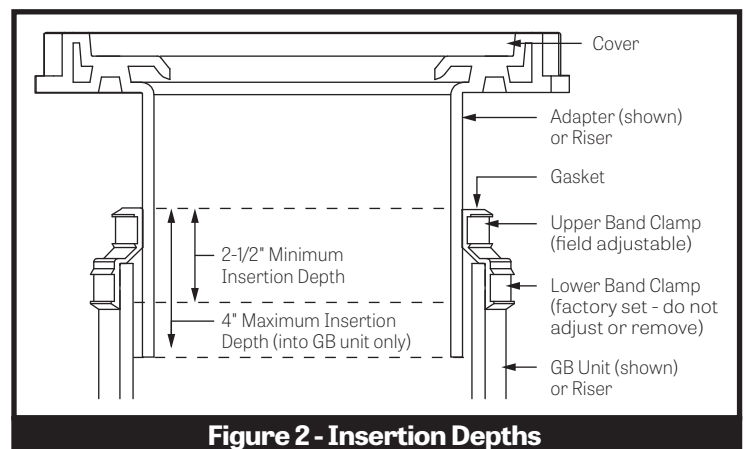
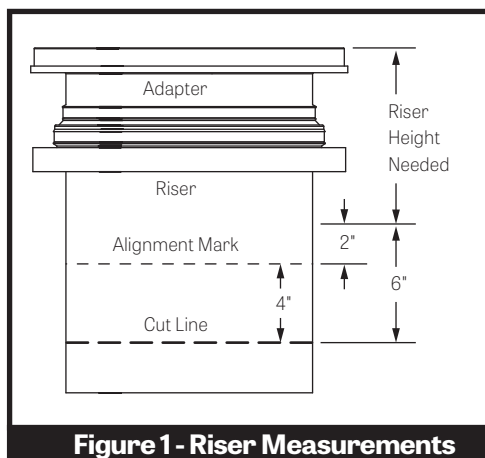

**SCHIER**  
LIFETIME GUARANTEED  
GREASE INTERCEPTORS

MODEL NUMBER:  
**SR24**

DESCRIPTION: 24" Short Riser Extension System

PART #: 8010-002-01

DWG BY: C. O'Boyle

DATE: 4/10/2019

REV: 0 / / /201\_

ECO: