



01050/23.1 NA

Replaces 01050/23 NA

MixCal™ Adjustable three-way thermostatic mixing valve

521 series



Function

The Caleffi MixCal™ 521 series three-way thermostatic mixing valve is used in systems producing domestic hot water or in hydronic and radiant heating systems. It maintains the desired output temperature of the mixed water supplied at a constant set value compensating for both temperature and pressure fluctuations of the incoming hot and cold water.

The MixCal thermostatic mixing valve is ICC-ES certified to ASSE 1017 and CSA B125.3. It complies with codes IPC, IRC, NPC and UPC for use in accordance with the US and Canadian plumbing codes, and standard NSF/ANSI/CAN 372, low lead.

Caleffi code 290030 full-port ball valve is designed for isolating the MixCal 521 series that has 1" metric "G" thread union connections. The isolation valve installs in between the valve body and the tailpiece fitting assembly. Male x Female configuration and bi-directional full ball valve flow capacity provides flexibility for using one or two isolation valves for the primary functioning valve. An optional stem extension is also available for those projects that require pipe insulation.

Product range

521__A series	Adjustable three-way thermostatic mixing valve with optional dual-scale outlet temperature gauge..... sizes ½", ¾", 1" with NPT male, sweat, press, PEX crimp and PEX expansion union
521__AC series	Adjustable three-way thermostatic mixing valve with inlet port check valves and optional dual-scale outlet temperature gauge sizes ½", ¾", 1" with NPT male, sweat, press, PEX crimp and PEX expansion union
521101A	Adjustable three-way thermostatic mixing valve, (replacement body)..... connections 1" male union thread with no fittings or union nuts

Technical specifications

Materials

- Body: low-lead brass (<0.25% Lead content)
- Shutter, seats and slide guides: PPO
- Springs: stainless steel
- Seals: peroxide-cured EPDM

Performance

Suitable fluids:	water, glycol solution
Max. percentage of glycol:	30%
Setting range:	85–150° F (30–65° C)
Tolerance:	±3° F (±2° C)
Max. working pressure (static):	200 psi (14 bar)
Max. operating differential pressure (dynamic):	75 psi (5 bar)
Max recommended differential pressure:	20 psi (1.5 bar)
Max. hot water inlet temperature:	200° F (93° C)
Max. inlet pressure ratio (H/C or C/H) for optimum performance:	2:1

Minimum temperature difference between hot water inlet and mixed water outlet for optimal performance:	27° F (15° C)
Minimum flow to ensure optimal performance:	1.0 gpm (3.8 L/min)
Minimum flow rate when recirculation flow rate is 1 gpm or greater:	0 gpm (0 L/min)
Outlet temperature gauge (optional):	2" diameter
	Dual-scale 30°F - 210°F and 0°C - 100°C

Certifications:

1. ASSE 1017/CSA B125.3, certified by ICC-ES, file PMG-1357.
2. NSF/ANSI/CAN 372-2011, Drinking Water System Components- Lead Content Reduction of Lead in Drinking Water Act, California Health and Safety Code 116875 S.3874, Reduction of Lead in Drinking Water Act, certified by ICC-ES, file PMG-1360.
3. PEX crimp fittings certified to ASTM F 1807.
4. PEX expansion fittings certified to ASTM F 1960.

Connections:

- NPT male union: ½", ¾", 1"
 - sweat union: ½", ¾", 1"
 - press union: ½", ¾", 1"
 - PEX crimp union: ½", ¾", 1"
 - PEX expansion: ½", ¾", 1"
- lay length-hot to cold inlet (press connections):
- | | |
|--------------------|--------|
| size ½ inch: | 3 5/8" |
| size ¾ inch: | 3 5/8" |
| size 1 inch: | 4 1/8" |
| size 1" with check | 7 1/4" |

Dimensions

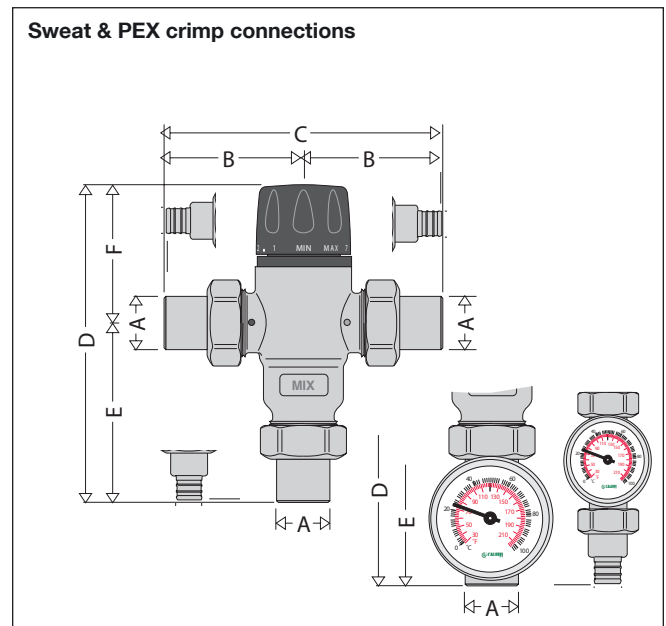
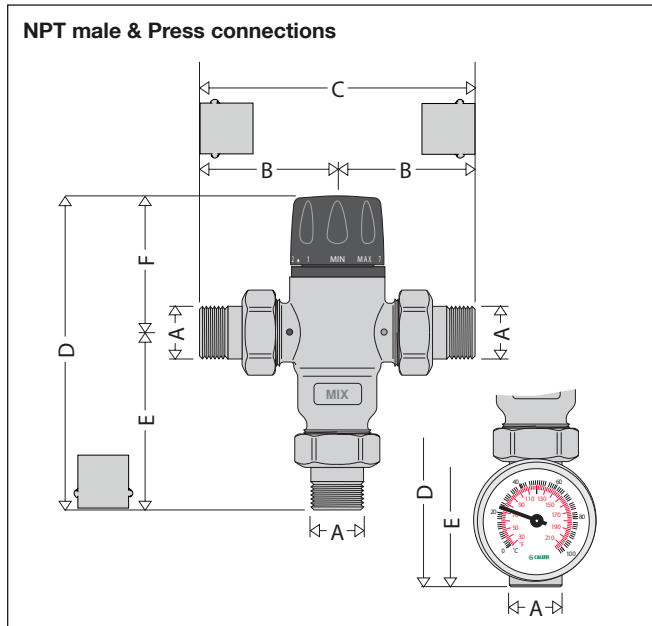

Code	A	B	C	D*	E	F	Wt. (lb.)
NPT Threaded connections							
521400A	1/2"	2 5/8"	5 1/4"	6"	3 3/8"	2 5/8"	2.4
521400AC	1/2"	2 5/8"	5 1/4"	6"	3 3/8"	2 5/8"	2.4
521410A**	1/2"	2 5/8"	5 1/4"	7 3/8"	4 3/4"	2 5/8"	2.9
521410AC**	1/2"	2 5/8"	5 1/4"	7 3/8"	4 3/4"	2 5/8"	2.9
521500A	3/4"	2 5/8"	5 1/4"	6"	3 3/8"	2 5/8"	2.4
521500AC	3/4"	3"	6"	6"	3 3/8"	2 5/8"	2.4
521510A**	3/4"	2 5/8"	5 1/4"	8"	5 3/8"	2 5/8"	2.9
521510AC**	3/4"	3"	6"	8"	5 3/8"	2 5/8"	2.9
521600A	1"	2 7/8"	5 3/4"	6 1/4"	3 3/4"	2 5/8"	2.4
521600AC	1"	3 1/16"	6 3/8"	6 1/4"	3 3/4"	2 5/8"	2.4
521610A**	1"	2 7/8"	5 3/4"	7 3/8"	5 1/8"	2 5/8"	2.9
521610AC**	1"	3 1/16"	6 3/8"	7 3/8"	5 1/8"	2 5/8"	2.9
Press connections							
521406A	1/2"	2 9/16"	5 1/8"	6"	3 3/8"	2 5/8"	2.4
521406AC	1/2"	3 3/16"	6 7/8"	6"	3 3/8"	2 5/8"	2.5
521416A**	1/2"	2 9/16"	5 1/8"	8 1/4"	5 5/8"	2 5/8"	2.9
521416AC**	1/2"	3 3/16"	6 7/8"	8 1/4"	5 5/8"	2 5/8"	3.0
521506A	3/4"	2 13/16"	5 5/8"	8 1/2"	5 7/8"	2 5/8"	2.4
521506AC	3/4"	4 3/16"	8 3/8"	8 1/2"	5 7/8"	2 5/8"	2.5
521516A**	3/4"	2 13/16"	5 5/8"	8 1/2"	5 7/8"	2 5/8"	2.9
521516AC**	3/4"	4 3/16"	8 3/8"	8 1/2"	5 7/8"	2 5/8"	3.0
521606A	1"	2 15/16"	5 7/8"	6 5/16"	3 11/16"	2 5/8"	2.6
521606AC	1"	4 5/16"	8 3/8"	6 5/16"	3 11/16"	2 5/8"	3.1
521616A**	1"	2 15/16"	5 7/8"	8 3/8"	6"	2 5/8"	3.1
521616AC**	1"	4 5/16"	8 3/8"	8 3/8"	6"	2 5/8"	3.5

C at the end of the code are models with integral inlet port check valves.

*At minimum temperature position on adjusting knob.

**Model with integral outlet temperature gauge.

Laylength (press):

sz 1/2 & 3/4 inch: 3 5/8"

sz 1 inch: 4 1/8"

sz 1 inch w/ checks: 7 1/4"

Code	A	B	C	D*	E	F	Wt. (lb.)
Sweat connections							
521409A	1/2"	2 1/4"	4 1/2"	5 5/8"	3 3/8"	2 5/8"	2.4
521419A**	1/2"	2 1/4"	4 1/2"	7"	4 1/2"	2 5/8"	2.9
521409AC	1/2"	2 7/8"	5 3/4"	5 5/8"	3 3/8"	2 5/8"	2.4
521419AC**	1/2"	2 7/8"	5 3/4"	7"	4 1/2"	2 5/8"	2.9
521509A	3/4"	2 1/2"	5"	5 13/16"	3 3/4"	2 5/8"	2.4
521519A**	3/4"	2 1/2"	5"	7 1/16"	5 1/4"	2 5/8"	2.9
521509AC	3/4"	3 1/16"	6 3/8"	5 13/16"	3 3/4"	2 5/8"	2.4
521519AC**	3/4"	3 1/16"	6 3/8"	7 1/16"	5 1/4"	2 5/8"	2.9
521609A	1"	3 1/16"	6 3/8"	6 7/16"	3 3/8"	2 5/8"	2.4
521619A**	1"	3 1/16"	6 3/8"	7 1/16"	5 1/4"	2 5/8"	2.9
521609AC	1"	3 1/4"	6 1/2"	6 7/16"	3 3/8"	2 5/8"	2.4
521619AC**	1"	3 1/4"	6 1/2"	7 1/16"	5 1/4"	2 5/8"	2.9
PEX crimp connections							
521407A	1/2"	3 1/4"	6 1/2"	6 1/2"	4"	2 5/8"	2.4
521417A**	1/2"	3 1/4"	6 1/2"	6 1/2"	4"	2 5/8"	2.5
521407AC	1/2"	3 1/4"	6 1/2"	6 1/2"	4"	2 5/8"	2.9
521417AC**	1/2"	3 1/4"	6 1/2"	8 3/4"	6 3/8"	2 5/8"	2.9
521507A	3/4"	3 1/4"	6 1/2"	6 1/2"	4"	2 5/8"	2.4
521517A**	3/4"	3 1/4"	6 1/2"	6 1/2"	4"	2 5/8"	2.5
521507AC	3/4"	3 1/4"	6 1/2"	6 1/2"	4"	2 5/8"	2.9
521517AC**	3/4"	3 1/4"	6 1/2"	8 3/4"	6 3/8"	2 5/8"	2.9
521607A	1"	3 1/4"	6 1/2"	6 1/2"	4"	2 5/8"	2.4
521617A**	1"	3 1/4"	6 1/2"	6 1/2"	4"	2 5/8"	2.5
521607AC	1"	3 1/4"	6 1/2"	6 1/2"	4"	2 5/8"	2.9
521617AC**	1"	3 1/4"	6 1/2"	8 3/4"	6 3/8"	2 5/8"	2.9

C at the end of the code are models with integral inlet port check valves.

*At minimum temperature position on adjusting knob.

**Model with integral outlet temperature gauge.

PEX expansion connections

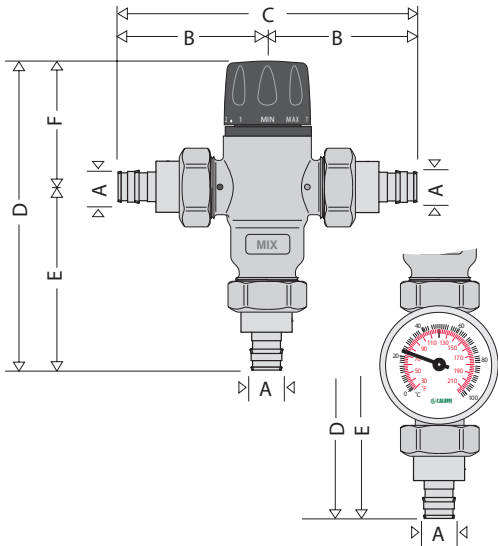

Code	A	B	C	D*	E	F	Wt. (lb)
521408A	1/2"	3 3/8"	6 3/4"	6 7/16"	3 13/16"	2 5/8"	2.4
521418A**	1/2"	3 3/8"	6 3/4"	7 13/16"	5 3/16"	2 5/8"	2.5
521408AC	1/2"	3 3/8"	6 3/4"	6 7/16"	3 13/16"	2 5/8"	2.9
521418AC**	1/2"	3 3/8"	6 3/4"	7 13/16"	5 3/16"	2 5/8"	2.9
521508A	3/4"	3 3/16"	6 3/8"	7 1/4"	4 5/8"	2 5/8"	2.4
521518A**	3/4"	3 3/16"	6 3/8"	9 1/4"	6 5/8"	2 5/8"	2.5
521508AC	3/4"	3 11/16"	7 3/8"	7 1/4"	4 5/8"	2 5/8"	2.9
521518AC**	3/4"	3 11/16"	7 3/8"	9 1/4"	6 5/8"	2 5/8"	2.9
521608A	1"	3 9/16"	7 7/8"	7 5/8"	5"	2 5/8"	2.4
521618A**	1"	3 9/16"	7 7/8"	9"	6 3/8"	2 5/8"	2.5
521608AC	1"	4 1/16"	8 1/8"	7 5/8"	5"	2 5/8"	2.9
521618AC**	1"	4 1/16"	8 1/8"	9"	6 3/8"	2 5/8"	2.9

C at the end of the code are models with integral inlet port check valves.

*At minimum temperature position on adjusting knob.

**Model with integral outlet temperature gauge.

Temperature — exposure time

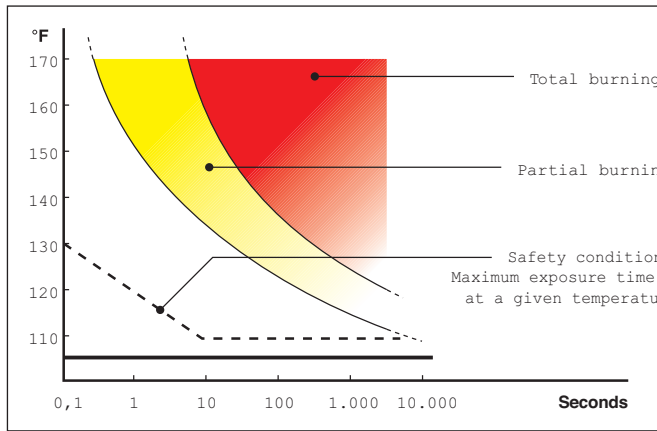

Legionella-scalding risk

In systems producing domestic hot water with storage, in order to avoid the dangerous infection known as Legionella, the hot water must be stored at a temperature of at least 140°F. At this temperature it is certain that the growth of the bacteria causing this infection will be totally eliminated. At this temperature, however, the water cannot be used directly.

As shown on the diagram opposite, temperatures of more than 120°F can cause burning very quickly. For example, at 130°F partial burning will occur in approximately 30 seconds, while at 140°F partial burning will occur in approximately 5 seconds. The time may be reduced by 50 percent or more for children and elderly people.

In view of the above, it is necessary to install a thermostatic mixing valve which can:

- reduce the temperature at the point of use to a value lower than that of storage and suitable for sanitary users. For safety reasons, it is advisable to limit the mixed water temperature to 120°F;
- maintain the temperature constant when the incoming pressure and temperature conditions vary.

Thermal disinfection

The diagram shows the behavior of the bacteria Legionella Pneumophila when the temperature conditions of the water in which it is contained vary. In order to ensure proper thermal "disinfection", the values must not be below 140°F.

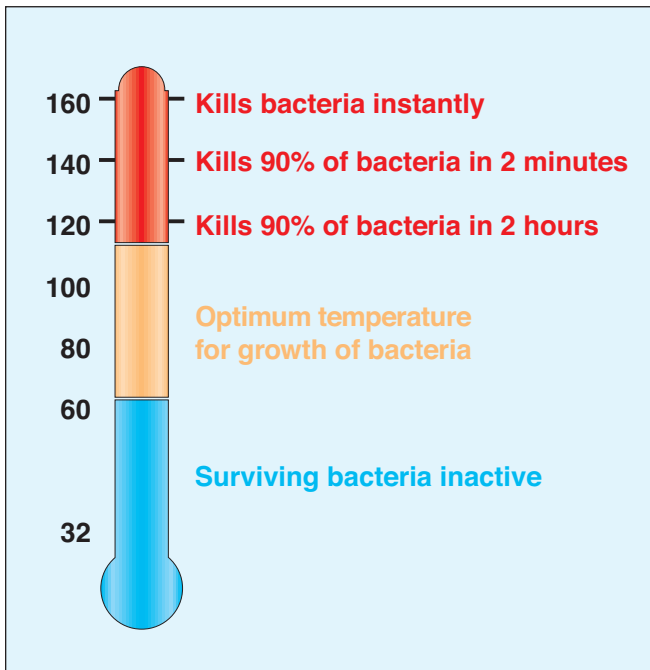

Operating principle

The controlling element of the three-way thermostatic mixing valve is a thermostatic sensor fully immersed in the mixed water outlet tube which, as it expands or contracts, continuously establishes the correct proportion of hot and cold water entering the valve. The regulation of these flows is by means of a piston sliding in a cylinder between the hot and cold water passages. Even when there are pressure drops due to the drawing off of hot or cold water for other uses, or variations in the incoming temperature, the thermostatic mixing valve automatically regulates the water flow to obtain the required temperature.

Construction details

Anti-scale materials

The material used in the construction of the Caleffi MixCal™ 521 series thermostatic mixing valve reduces jamming caused by lime deposits. All the working parts such as shutter, seats and slide guides are made of a special anti-scale material, with a low friction coefficient, assuring stable temperature control and long operating life.

Temperature setting and locking

The control knob permits temperature setting between minimum and maximum in one turn (360°). It also has a tamper-proof system to lock the temperature at the set value.

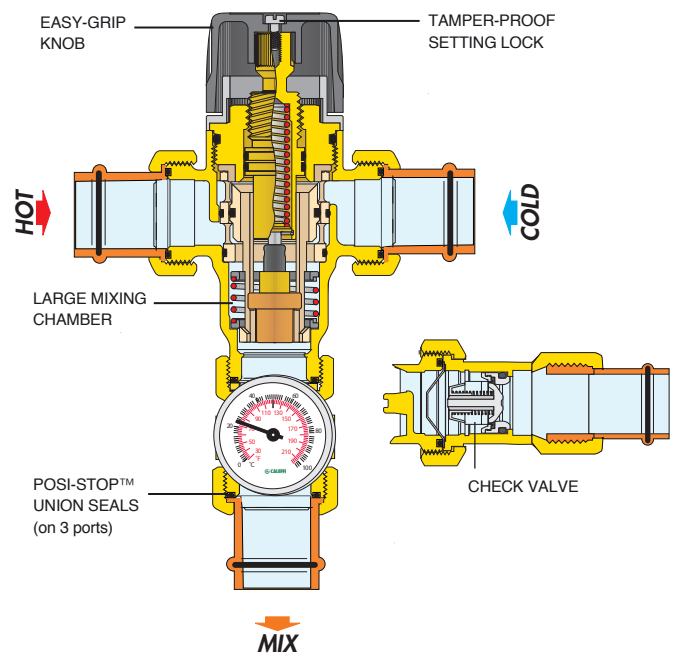

Flow curve

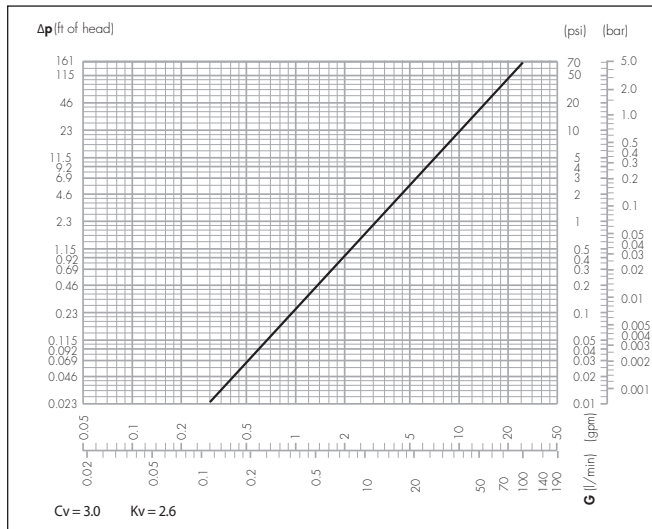

Flow should never exceed standards for pipe size and materials.

Use

Caleffi MixCal™ 521 series thermostatic mixing valves are designed to be installed at the hot water heater. The 521 series valve cannot be used for tempering water temperature at fixtures as a point-of-use valve. They are not designed to provide scald protection or chill protection service. They should not be used where ASSE 1070 devices are required. Wherever a scald protection feature is required, Caleffi 5213 series high performance mixing valves need to be installed. For safety reasons, it is advisable to limit the maximum mixed water temperature to 120°F.

Instantaneous production of hot water

Caleffi 5231 series thermostatic mixing valves are designed for use on domestic water heaters that have storage. The valve may deliver fluctuating mixed temperatures when used on instantaneous domestic water heaters.

Radiant heating systems

Caleffi MixCal™ 521 series thermostatic mixing valves can also be used for regulating the flow temperature in hydronic and radiant heating systems, to which it assures a constant and accurate control with ease of installation.

Temperature stability

The diagram shows the stability of the temperature of the mixed water on variation of the temperature of the stored water.

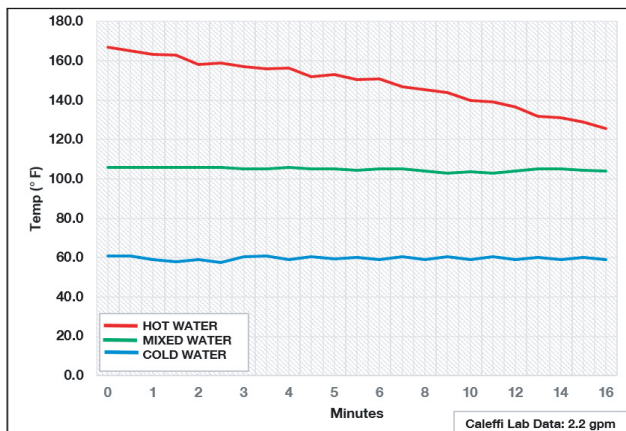

Installation

Before installing a Caleffi MixCal™ 521 series three-way thermostatic mixing valve, the system must be inspected to ensure that its operating conditions are within the range of the mixing valve, checking, for example, the supply temperature, supply pressure, etc.

Systems where the 521 series thermostatic mixing valve will be installed must be drained and cleaned out to remove any dirt or debris which may have accumulated during installation.

The installation of appropriately sized filters at the inlet from the main water supply is always advisable.

Caleffi MixCal™ 521 series thermostatic mixing valves must be installed by qualified personnel in accordance with the diagrams in this brochure, taking into account all current applicable standards.

Caleffi MixCal™ 521 series thermostatic mixing valves can be installed in any position, either vertical or horizontal, or upside down.

The following are shown on the thermostatic mixing valve body:

- Hot water inlet, color red and marked "HOT".
- Cold water inlet, color blue and marked "COLD".
- Mixed water outlet, marked "MIX".

Check valves

In order to prevent undesirable backsiphonage, check valves should be installed in systems with thermostatic mixing valves. As a convenience for easier installations, the Caleffi MixCal™ 521 "AC" series thermostatic mixing valves include integral check valves in the hot and cold inlet ports.

Commissioning

The Caleffi MixCal™ 521 series thermostatic mixing valve must be commissioned in accordance with current standards by qualified personnel using temperature measuring equipment. Caleffi 521419A, 521519A and 521619A with integral outlet port temperature gauges provide a time-saving temperature setting process to get close to the desired temperature. Use of a digital thermometer is recommended for determining the final setting of the mixed water temperature. Note: For models purchased without the outlet temperature gauge, the temperature gauge adapter with temperature gauge can be separately purchased and field installed, code NA10328 for 1/2" models, code NA10056 for 3/4" models or code NA10058 for 1" models.

Temperature adjustment

The temperature is set to the required value by means of the knob with the graduated scale, on the top of the valve.

Pos.	Min.	1	2	3	4	5	6	7	Max.
T (°F)	81	90	100	111	120	127	136	145	152
T (°C)	27	32	38	44	49	53	58	63	67

with: $T_{HOT} = 155^{\circ}F (68^{\circ}C)$, with: $T_{cold} = 55^{\circ}F (13^{\circ}C)$, $P = 43 \text{ psi } (13 \text{ bar})$

Locking the setting

Position the handle to the number required with respect to the index point. Unscrew the head screw, pull off the handle and reposition it so that the handle fits into the internal slot of the knob. Tighten the head screw.

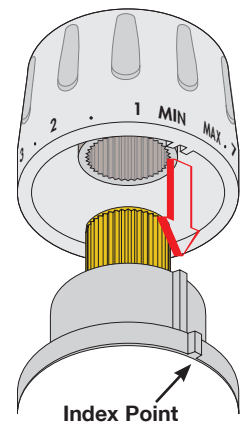

Replacement parts and accessories



Replacement body.
Meets requirements of
NSF/ANSI/CAN 372-2011.
Certified to: ASSE 1017/CSA B125.3,
Low lead, by ICC-ES file PMG-1360.



Point of distribution mixed temperature
gauge adaptor fits MixCal™ 521 series
mixing valves. Threaded union mounting
replaces existing mixed outlet with 3/4" or 1"
sweat pipe connection. Removable gauge
fits into temperature well. Gauge dial is 2"
diameter and dual-scale (not pictured) from
30—210° F (0—100° C).



521101A.....1" male union thread

- NA10328.....1/2" sweat with gauge
- NA10056.....3/4" sweat with gauge
- NA10058.....1" sweat with gauge
- NA103581" union thread with gauge
- 688003A.....replacement gauge with pocket well
- R39591.....replacement gauge
- NA10498.....pocket well, plated



Replacement check valves.



Conical inlet filter.

Isolation ball valve



Low lead Male x Female union fits 1" valves
between body and tailpiece. See below.

Replacement fittings

Refer to current Caleffi Plumbing and Hydronics Catalog, fittings and
miscellaneous components section for replacement tailpiece, union nut and
washer parts.

290030.....isolation ball valve 1" M x 1" F union



Isolation ball valves, installed on MixCal without
optional temperature gauge.

Recirculation with point-of-distribution thermostatic mixing valves

For domestic recirculating water systems that include a single ASSE 1017 point-of-distribution thermostatic mixing valve, such as the Caleffi MixCal™ 521 series, the piping installation below is recommended.

In any recirculating hot water distribution system there will be times when the circulator is operating, but no hot water is being drawn at the fixtures. Under this condition, heat continually dissipates from the piping forming the recirculation loop. If the loop is relatively short, and well insulated, the rate of heat loss should be very small. If the loop is long, and uninsulated, the rate of heat loss could be substantially greater.

To maintain the recirculating water at the desired delivery temperature the heat lost from the loop must be replaced. This requires some water flow between the loop and the hot water source. Ideally, this flow is adjusted so that the rate of heat transfer from the hot water source to the loop exactly balances the rate of heat loss from the loop's piping.

The figure (below) shows a “bypass valve” (1), and “return valve” (2), which regulate how much warm water from the return side of the recirculating loop flows back to the storage tank. When there is no demand for hot water at the fixtures, the flow of return water to the tank will equal the rate of hot water flow from the tank to the inlet port of the mixing valve. Ideally, this flow should be adjusted so that the rate of heat transfer from the tank to the recirculating loop exactly balances the rate of heat loss from the recirculating loop. This allows the water temperature leaving the mixing valve to remain stable.

The bypass valve (1) and possibly the return valve (2) must be adjusted when there is no domestic water draw on the recirculating loop (when all the fixtures are off). Begin with the bypass valve (1) fully closed, and the return valve (2) fully open. Turn on the recirculating circulator and let it run for several minutes. The supply water temperature leaving the mixing valve will likely be lower than the setting of the valve, since there is no return flow to the tank thus, no hot water to the hot port of the mixing valve.

Slowly open the bypass valve (1) and monitor the temperature leaving the mixing valve. It will likely begin rising as some water returns to the tank, and an equal flow of hot water moves from the tank to the hot port of the mixing valve. When the temperature leaving the mixing valve remains stable, and is at or very close to the temperature set on the mixing valve, the bypass valve is correctly set.

The return valve (2) can remain fully open unless a situation occurs where the bypass valve (1) is fully open, but the temperature leaving the mixing valve is still too low. If this occurs, partially close the return valve (2) to add flow resistance. This forces more flow through the bypass valve (1). Repeat the previously described procedure of slowly opening the bypass valve (1) until the water temperature leaving the mixing valve is stable.

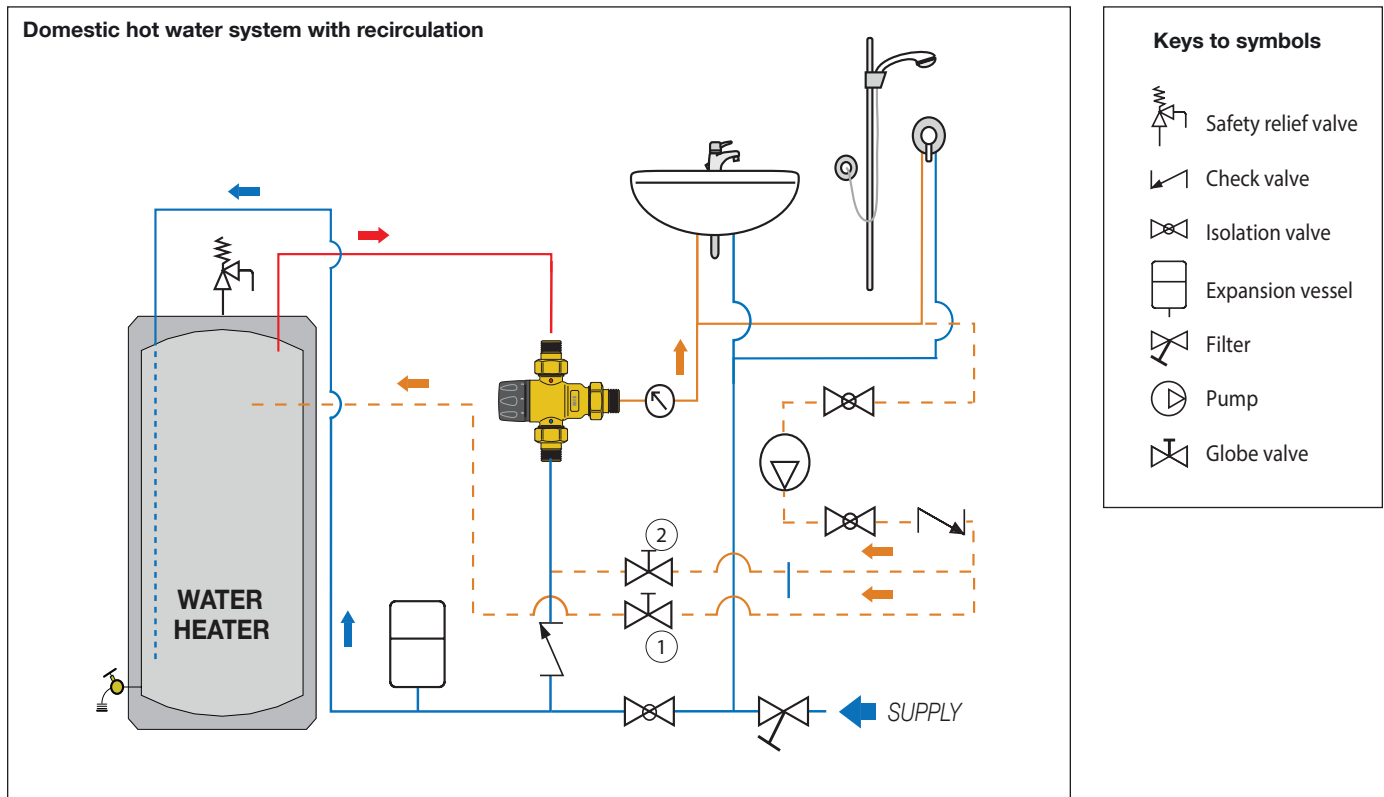

Application diagrams

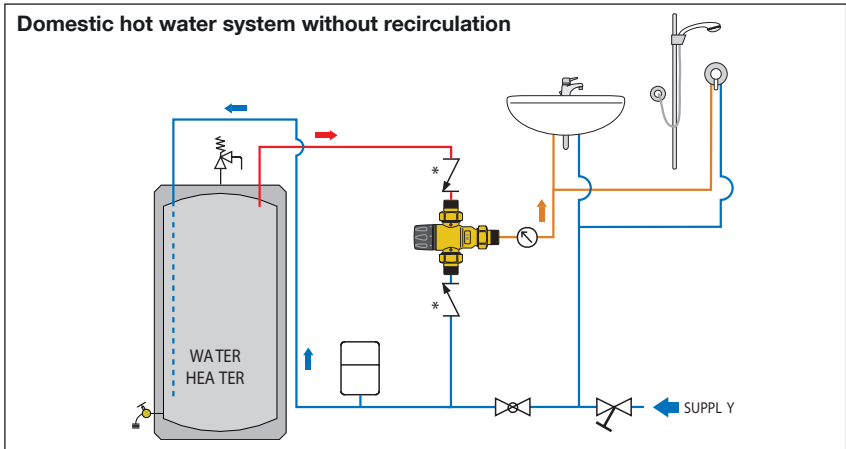
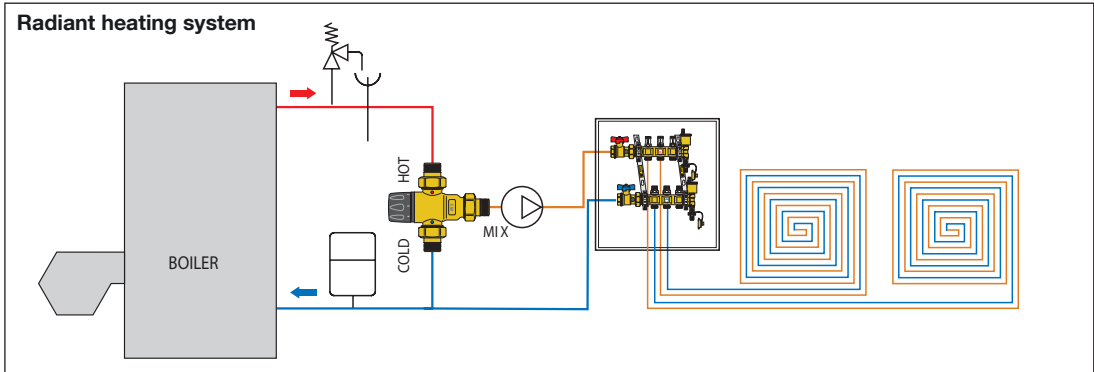

Keys to symbols

- Safety r elief valve
- Check valve
- Isolation valve
- Expansion vessel
- Filter
- Pump

**MixCal™ 521 series thermostatic mixing valves with inlet check valves, "AC" models, can be used instead of separately installed check valves.*

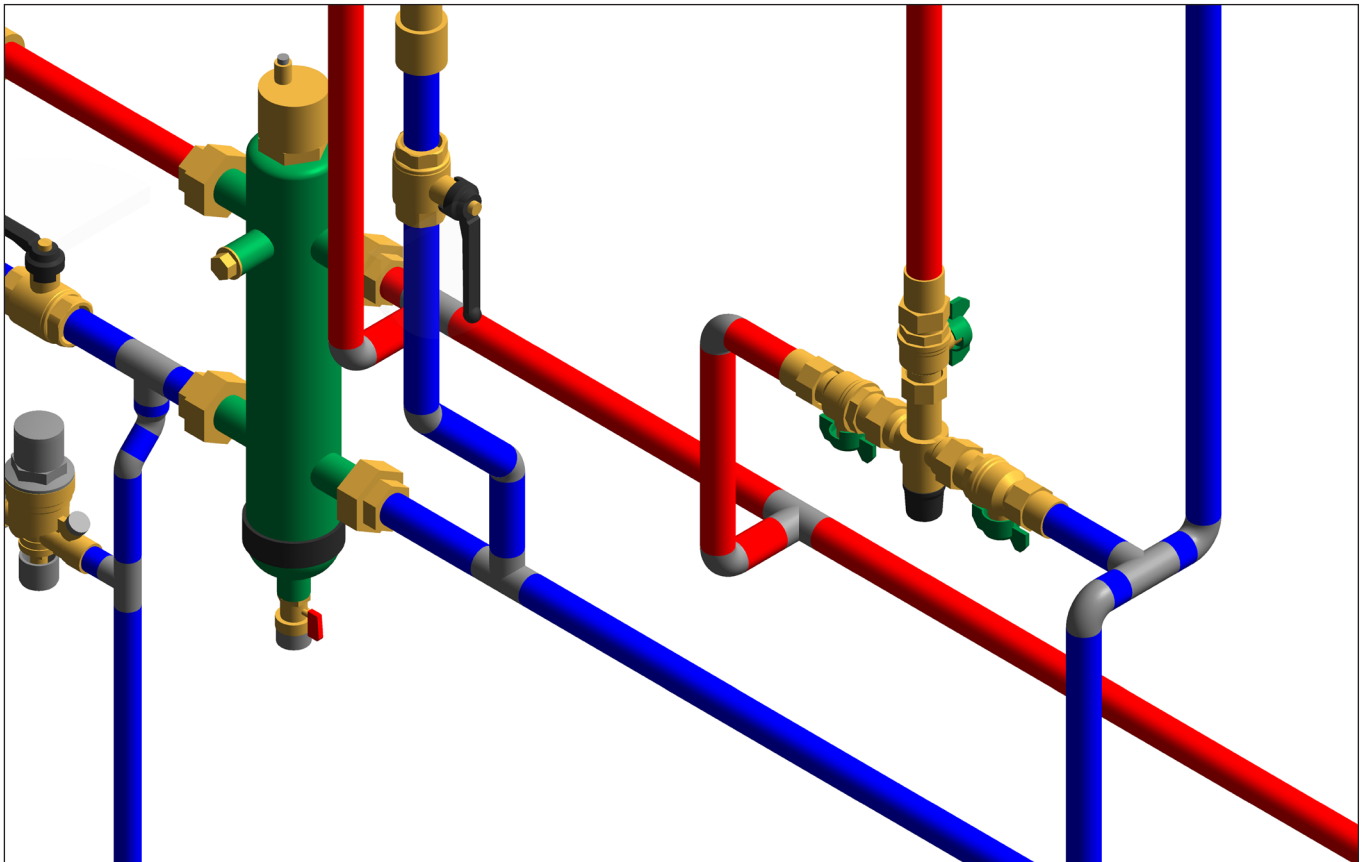

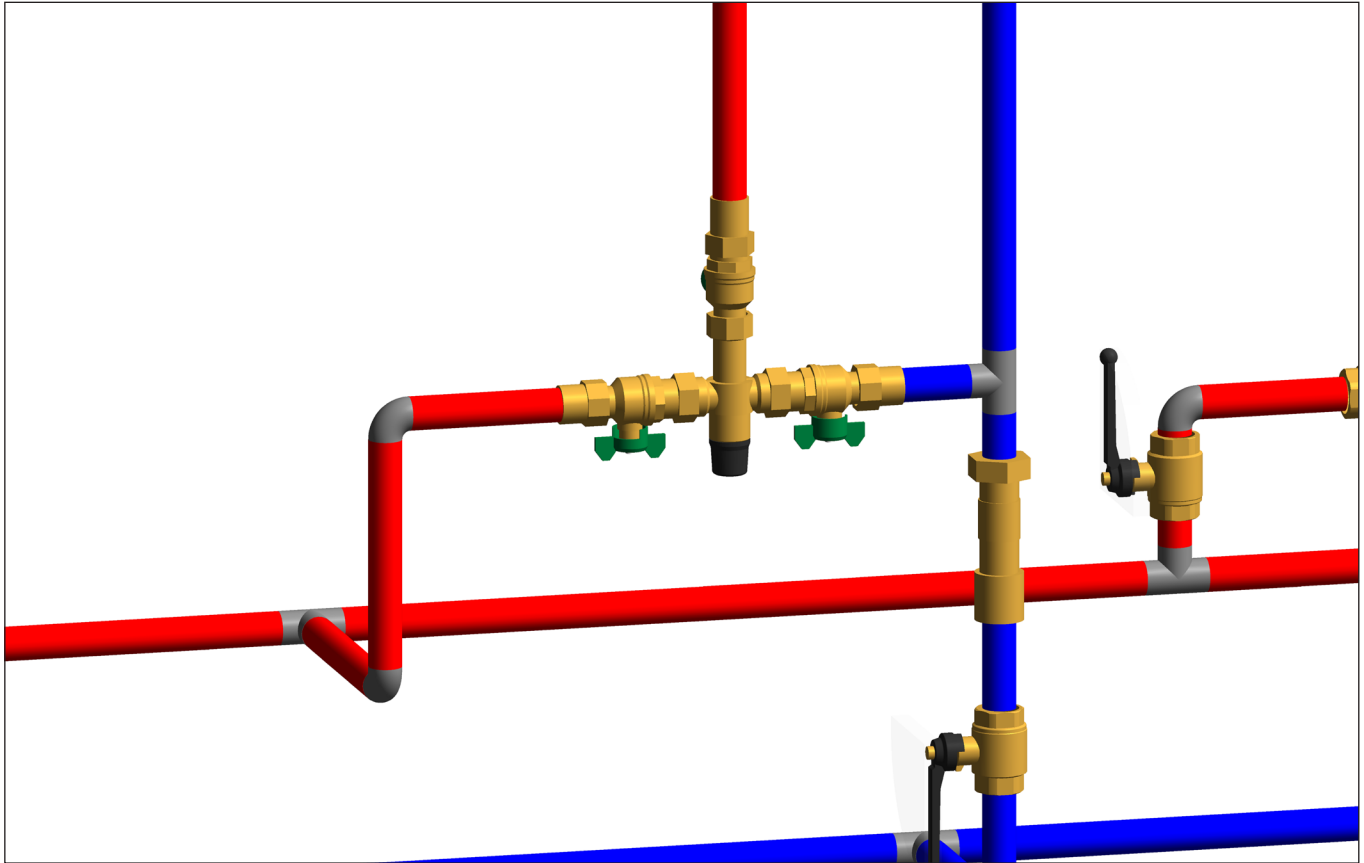

Find us in

MasterSpec®

Powered by Deltek Specpoint®

<https://get.caleffi.info/specpoint>



find BIM Revit files and system templates at
<https://bim.caleffi.com/en-us>

SPECIFICATION SUMMARY

MixCal™ 521 series

Adjustable thermostatic and pressure balanced mixing valve, certified by ICC-ES to ASSE 1017-2009 and CSA B125.3, approved for point of distribution domestic water systems and radiant hydronic heating systems. Sweat, Press, PEX crimp, PEX expansion and threaded connections 1/2", 3/4" or 1" NPT male with union tailpieces. Low-lead brass body (<0.25% Lead content) certified by ICC-ES file 1360. Meets requirements of NSF/ANSI/CAN 372-2011. Shutter, regulating seats and sliding surfaces in anti-scale plastic, PPO. Seals peroxide-cured EPDM. Stainless steel spring. Maximum working temperature 200 degrees F (93 degrees C). Setting range 85 degrees F to 150 degrees F (30 degrees C to 65 degrees C). Maximum working pressure 200 psi (14 bar). Maximum operating differential pressure 75 psi (5 bar). Tolerance ±3 degrees F (±2 degrees C). Flow rating: Cv 3.0. Minimum flow to ensure optimal performance: 1.0 gpm (3.8 L/min). Minimum flow rate when recirculation flow rate is 1 gpm or greater: 0 gpm. Provided with tamper-proof setting lock. Provide with optional inlet port check valves. Provide with optional mixed outlet dual-scale temperature gauge, 30 to 210 degrees F scale and 0 to 100 degree C scale, 2 inch diameter. Provide with optional inlet and outlet isolation ball valves, code 290030, separately sourced, field installed.

We reserve the right to change our products and their relevant technical data, contained in this publication, at any time and without prior notice.



Caleffi North America, Inc.
 3883 W. Milwaukee Road, Milwaukee, WI 53208
 Tel: 414-238-2360 · Fax: 414-238-2366
 Technical Support: 414-338-6338 / techsupport.us@caleffi.com
 sales@caleffi.com · www.caleffi.com
 © Copyright 2023 Caleffi North America, Inc.