

INSTALLATION GUIDE

GB3 50/75 GPM Grease Interceptor for Indoor Use

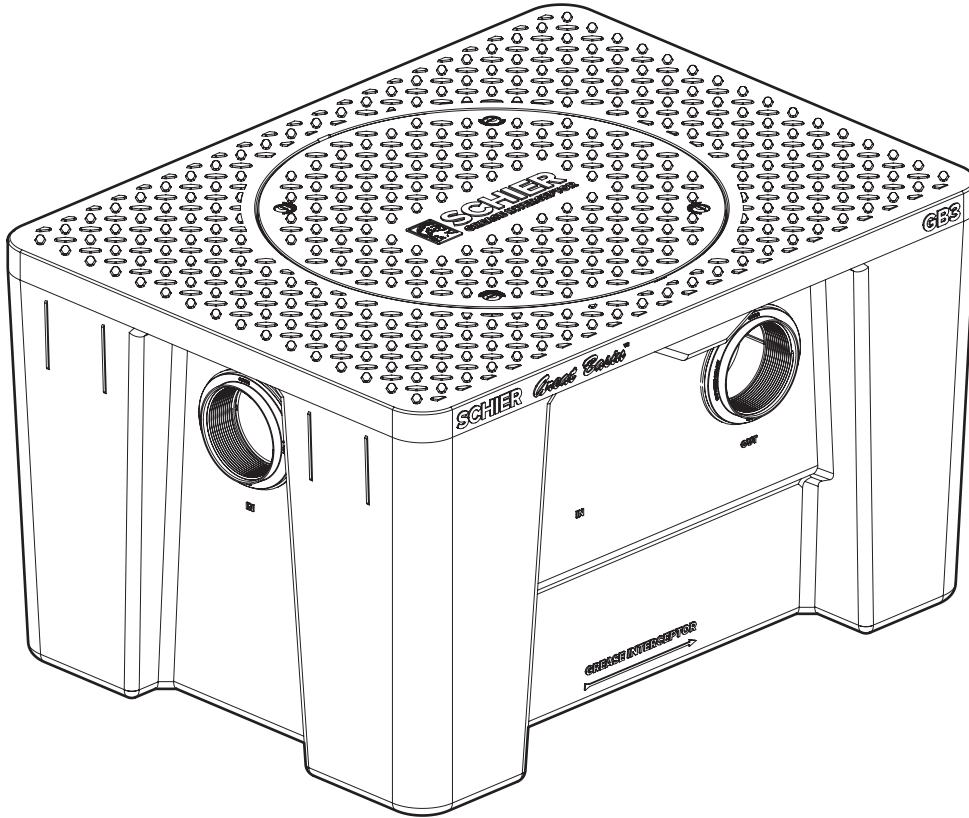

Contents

Special Precautions	2-3
Getting to Know the GB3	4
On the Floor Installation	5-7
Buried Installation	8-10



SCHIER
LIFETIME GUARANTEED
GREASE INTERCEPTORS



SPECIAL PRECAUTIONS

For Schier Grease Interceptor Installations – Failure to follow this guidance voids your warranty

WARNING! DO NOT AIR TEST UNIT OR RISER SYSTEM! Doing so may result in property damage, personal injury or death.

CAUTION! Do not install this unit in any manner except as described in these instructions.

Installation Instructions

Installation instructions and additional components are included with the interceptor. Read all instructions prior to installation. This interceptor is intended to be installed by a licensed plumber in conformance with all local codes.

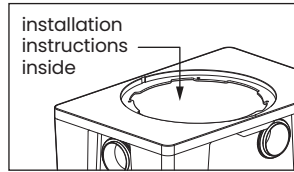

High Temperature Kitchen Water

If water is entering the interceptor at excessive temperature (over 150° F), a drain water tempering valve (DTV) and approved backflow prevention assembly must be installed. Most state and local plumbing codes prohibit water above 150° F being discharged into the sanitary sewer. Water above 150° F will weaken or deform PVC Schedule 40 pipe, poly drainage fixtures like interceptors and erode the coating of cast iron (leading to eventual failure).

When Installing Interceptor Inside

If your dishwashing sink(s) discharges into a floor drain/sink (drain), you must regulate the flow into the drain to avoid an overflow of water onto the kitchen floor. This can be done by installing a valve or flow restriction cap on the sink piping that discharges into the drain.

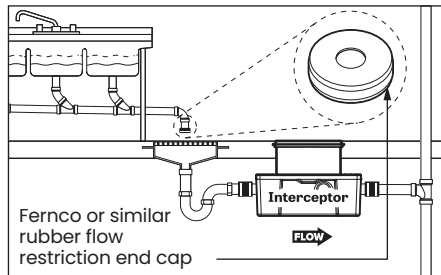

See drawing for guidance. For detailed guidance on indirect connections, go to: webtools.schierproducts.com/Technical_Data/Indirect_Connections.pdf

ODOR ALERT!

Do not install air gap on outlet side of interceptor.

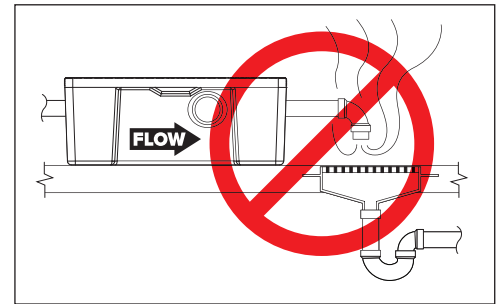

Hydrostatic Slabs (or Pressure Slabs)

When installed under a hydrostatic slab (slab designed to withstand upward lift, usually caused by hydrostatic pressure) interceptor must be enclosed in a watertight concrete vault.

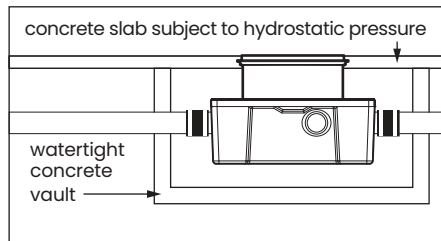



SPECIAL PRECAUTIONS

For Schier Grease Interceptor Installations – Failure to follow this guidance voids your warranty

High Water Table Installations

Interceptors and risers are not designed to withstand water table height in excess of the top of the unit when buried (see figure). If it is possible for this to occur, install the interceptor and risers in a water-tight concrete vault or backfill with concrete or flowable fill (wet concrete and flowable backfill should be poured in stages to avoid crushing the interceptor). At risk areas include but are not limited to tidal surge areas, floodplains and areas that receive storm water. Great Basin™ models that are direct buried in high water table scenarios must be installed with an anchor kit. Models GB-50, GB-75, and GB-250 use model AK1 anchor kit. Model GB-500 uses model AK2 anchor kit for use with deadmen anchors. Models GB-1000, GGI-750 and GGI-1500 use model AK3 anchor kit for use with deadmen anchors.

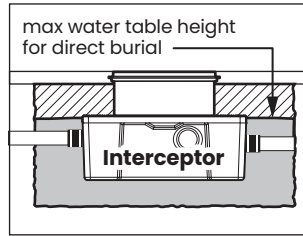

Flush-to-Grade Burials

Flush-to-Grade buried installations (without a riser) are not recommended for heavy foot traffic areas without the use of an internal gusset support kit **SGK2** (for GB2) or **SGK3** (for GB3).

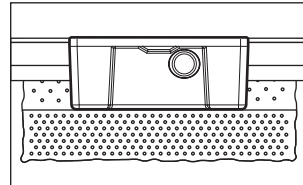

Fully Support Base of Unit

Install unit on solid, level surface in contact with the entire footprint of unit base; for suspended installations design trapeze to support the wet weight of the unit. Do not partially support unit or suspend unit using metal U-channel to create a trapeze.

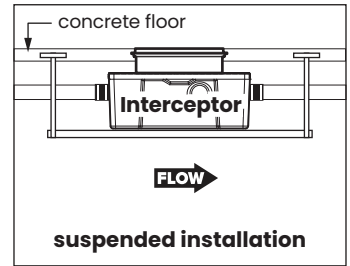

Support Inlet and Outlet Piping

For above grade installations ensure heavy inlet and outlet piping (such as cast iron or long runs) is properly supported or suspended during the entire installation process to prevent connection failure or damage to bulkhead fittings.

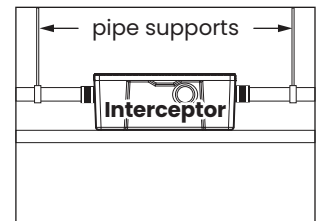

DO NOT COMPACT BACKFILL

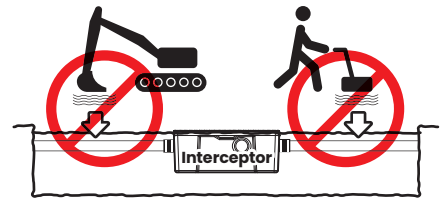

GETTING TO KNOW THE GB3

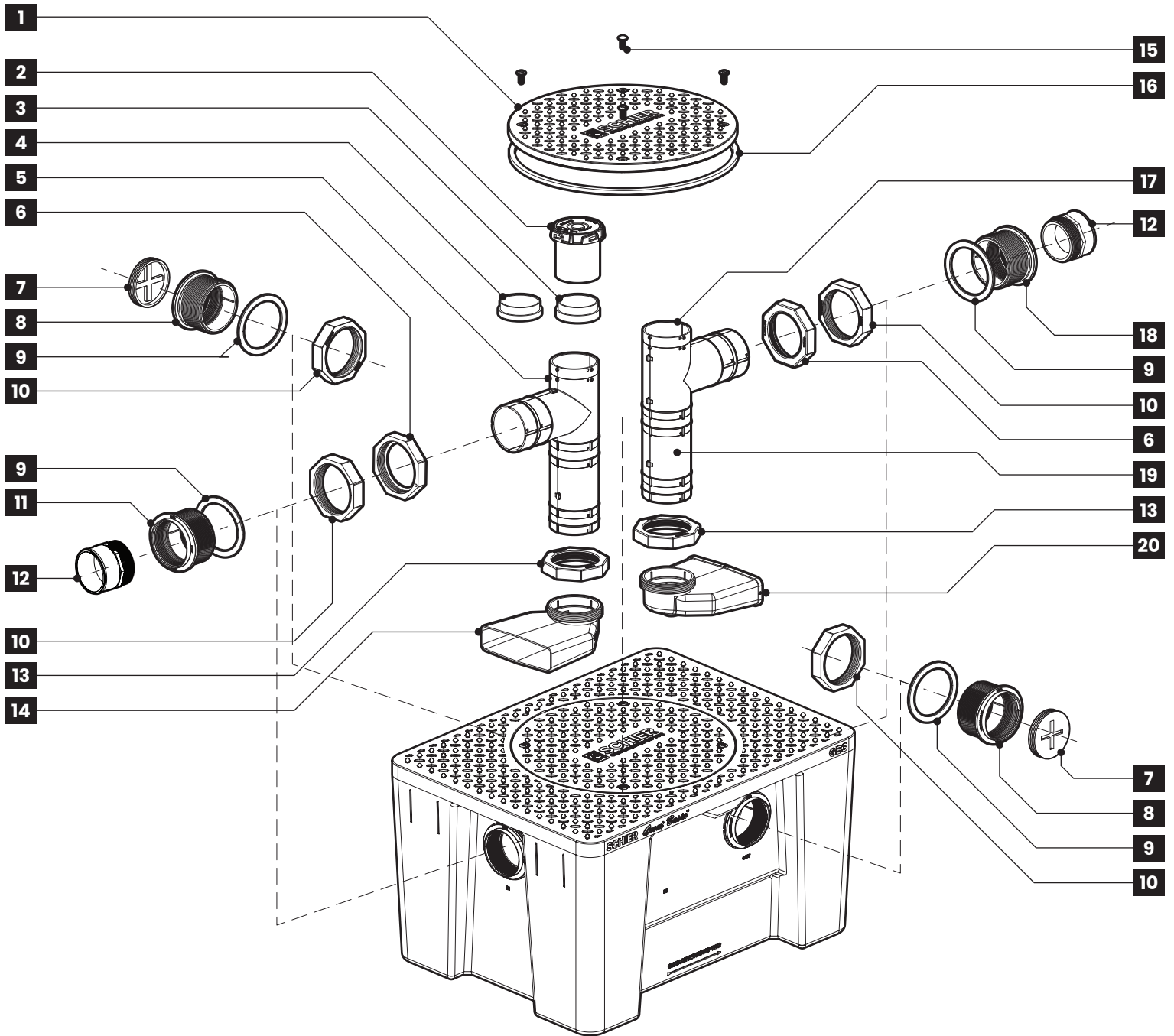

- | | | |
|--|--|-------------------------------------|
| 1. Cover | 7. 4" Cleanout Plug (x2) | 14. Inlet Diffuser (Foot) |
| 2. Standard Installation Flow Control Cartridge | 8. Optional Side Outlets 4" FPT (x2) | 15. Cover Bolts (x4) |
| 3. 50 GPM Flow Control Extension (>5' below kitchen only) | 9. Connection Fitting Gaskets (x4) | 16. Cover Gasket |
| 4. 75 GPM Flow Control Extension (>5' below kitchen only) | 10. Bulkhead Connection Retaining Nuts (x4) | 17. Air Relief/Visual Access |
| 5. Inlet Diffuser (Top) | 11. Inlet 4" FPT Connection | 18. Outlet 4" FPT Connection |
| 6. Diffuser Retaining Nuts (x2) | 12. 4" Plain End Fittings (x2) | 19. Outlet Diffuser (Top) |
| | 13. Diffuser Foot Retaining Nuts (x2) | 20. Outlet Diffuser (Foot) |

ON THE FLOOR INSTALLATION

Special Precautions

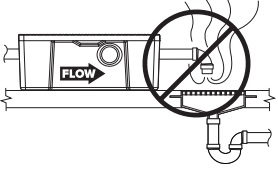
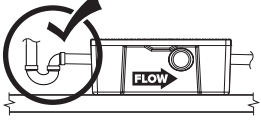
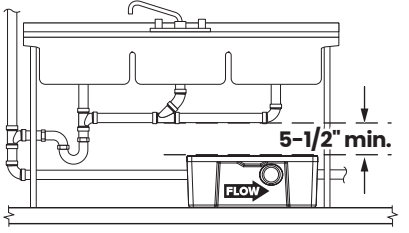
<p>1 ODOR ALERT! Do not install air gap on outlet side of interceptor.</p> 	<p>3 ODOR ALERT! Interceptor is not a sewer gas trap. All upstream fixtures must be trapped.</p> 	<p>4 Provide at least 5-1/2" clearance above unit for routine maintenance.</p> 
<p>2 Install interceptor as close as possible to fixtures being served</p>		

1 Test Tank for Water Tightness

1a Cap all connection points with 4" cleanout plugs using pipe thread sealant or tape approved for use with plastics.

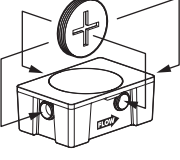

1b Remove cover and fill with water to just above the highest connection. For riser system testing (if required) fill to finished grade level. **CAUTION:** Support risers before filling to prevent tipping. Inspect unit, connections and gaskets for leaks. Check water level at specific time intervals per local code.

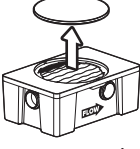

Leak?
Call customer care at 913-951-3300
8a - 5p M - F CST

2 Set Up Outlet Diffuser and Install Cleanout Plugs

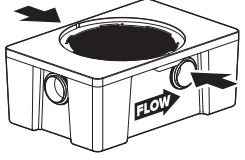
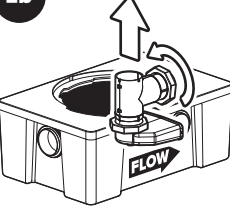
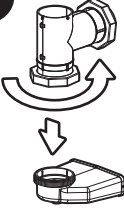
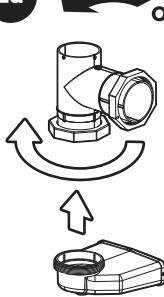
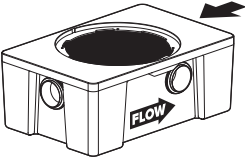
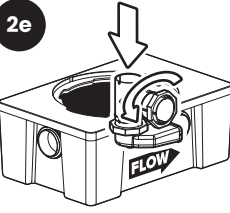
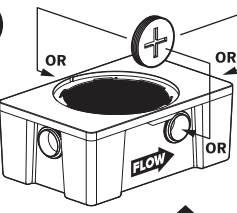
<p>2a Choose outlet location.</p>  <p>Side outlet</p>	<p>2b Unscrew diffuser retaining nut and remove outlet diffuser.</p> 	<p>2c Unscrew diffuser foot retaining nut and remove outlet diffuser foot.</p> 	<p>2d Rotate diffuser toward chosen outlet, replace foot ensuring it will point to the back wall of the unit and hand tighten foot retaining nut.</p> 
<p>OR</p>  <p>Straight-through</p>	<p>2e Insert diffuser into chosen outlet and hand tighten retaining nut.</p> 	<p>2f</p> 	<p>Cap all unused connection points with 4" cleanout plugs using pipe thread sealant or tape approved for use with plastics.</p>

ON THE FLOOR INSTALLATION

3 Calibrate Flow Control

Figure 1

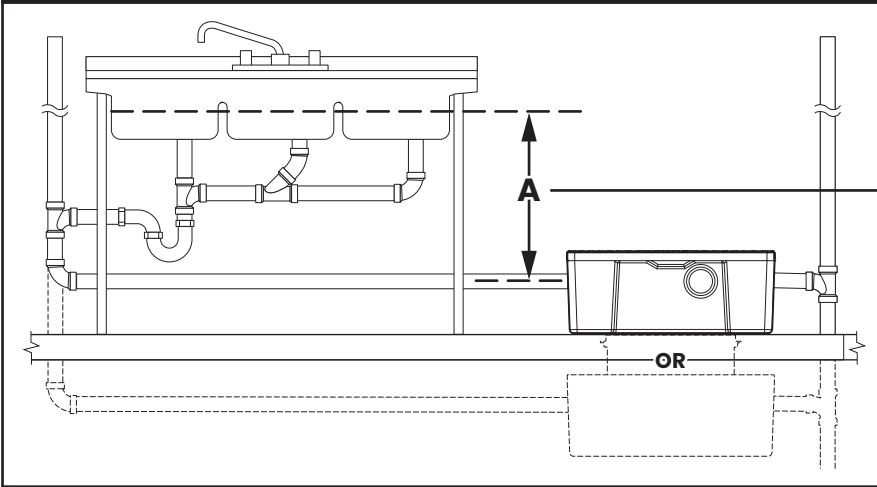

Note to Plumbing Inspector This interceptor includes certified internal flow control and does not require a dedicated "Flow Control Vent" (air intake).

- If dimension **A** is 5 feet or less **go to Step 4.**
- If dimension **A** is greater than 5 feet **follow Steps below.**

3a1

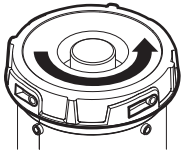

Rotate flow control cartridge counter-clockwise to release and remove from inlet diffuser

3a2

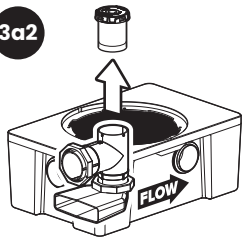

3b

Depending on which flow rate is desired, attach either the 50 or 75 GPM Flow Control Cartridge Extension using PVC primer/cement. **Make sure extension is fully inserted into the cartridge and hold both components firmly together (until cement grabs) to prevent push-out.**

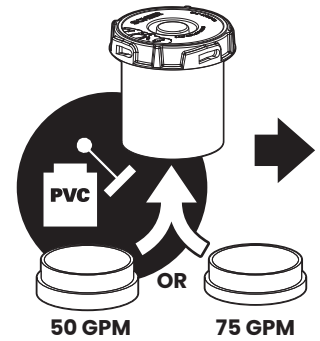

3c1

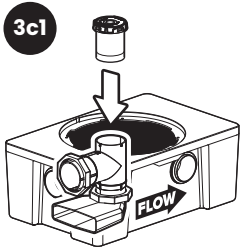

3c2

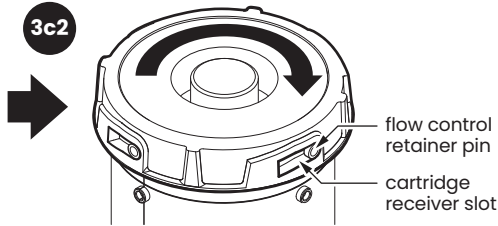

Slide flow control cartridge into top of inlet diffuser and rotate clockwise until cartridge drops onto flow control retainer pins. Continue rotating clockwise until pins are fully seated.

ON THE FLOOR INSTALLATION

4 Connect Piping

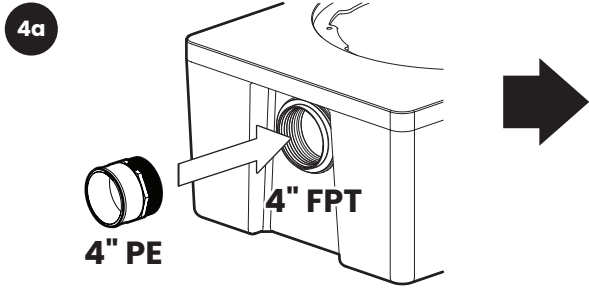

Choose inlet and outlet fittings (included) based on pipe size.

4b Connect piping using pipe thread sealant or tape approved for use with plastics. Ensure all upstream fixtures are trapped. **Vent per local code.**

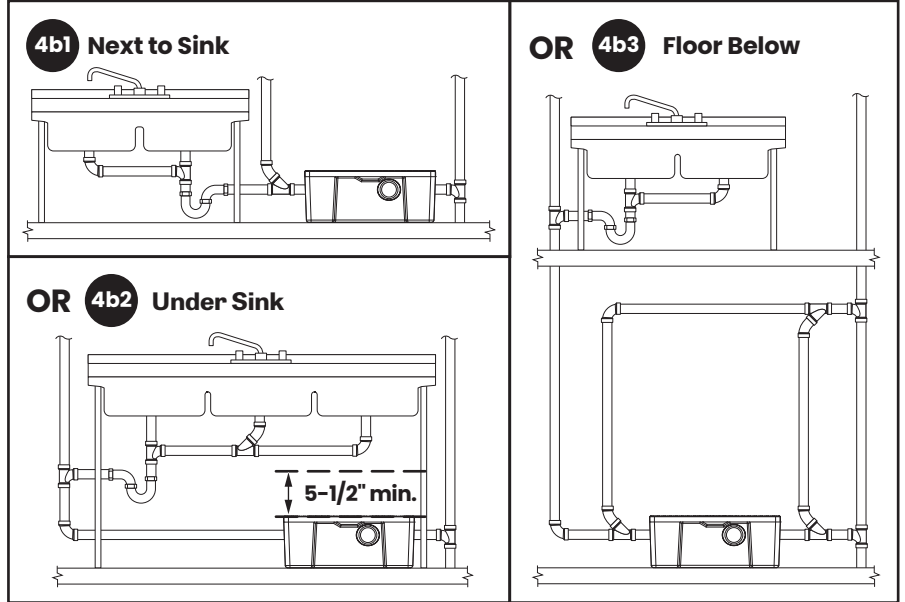

5 Wet or Air Test Piping Per Local Code

WARNING! DO NOT AIR TEST UNIT OR RISER SYSTEM!
Doing so may result in property damage, personal injury or death.



Leak? Call customer care at
913-951-3300
8a – 5p M – F CST

BURIED INSTALLATION

Special Precautions

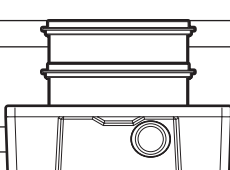
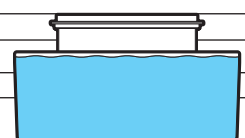
<p>1</p> <p>Install interceptor as close as possible to fixtures being served</p>	<p>2</p> <p>2 Risers (25") Max</p> 	<p>3</p> <p>Max Water Level Risers are not designed to retain water</p> 
--	--	--

1 Test Tank for Water Tightness

1a Cap all connection points with 4" cleanout plugs using pipe thread sealant or tape approved for use with plastics.

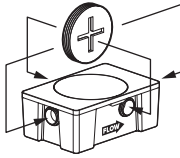

1b Remove cover and fill with water to just above the highest connection. For riser system testing (if required) fill to finished grade level. **CAUTION:** Support risers before filling to prevent tipping. Inspect unit, connections and gaskets for leaks. Check water level at specific time intervals per local code.

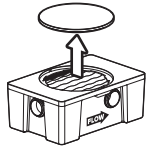

Leak?
Call customer care at 913-951-3300
8a - 5p M - F CST

2 Set Up Outlet Diffuser and Install Cleanout Plugs

2a Choose outlet location.

Side outlet

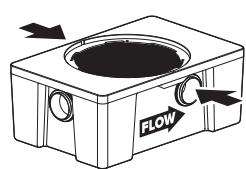

2b Unscrew diffuser retaining nut and remove outlet diffuser.

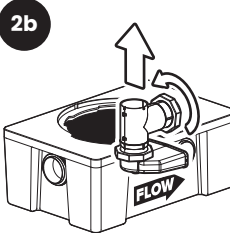

2c Unscrew diffuser foot retaining nut and remove outlet diffuser foot.

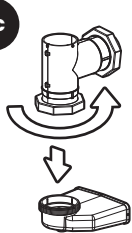

2d Rotate diffuser toward chosen outlet, replace foot ensuring it will point to the back wall of the unit and hand tighten foot retaining nut.

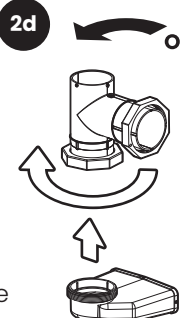

OR

2e Insert diffuser into chosen outlet and hand tighten retaining nut.

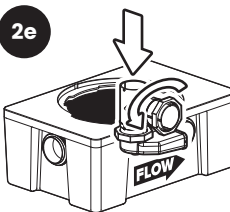

2f Cap all unused connection points with 4" cleanout plugs using pipe thread sealant or tape approved for use with plastics.

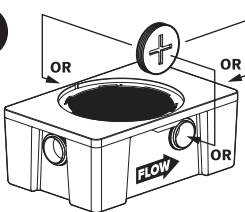

Straight-through

BURIED INSTALLATION

3 Calibrate Flow Control

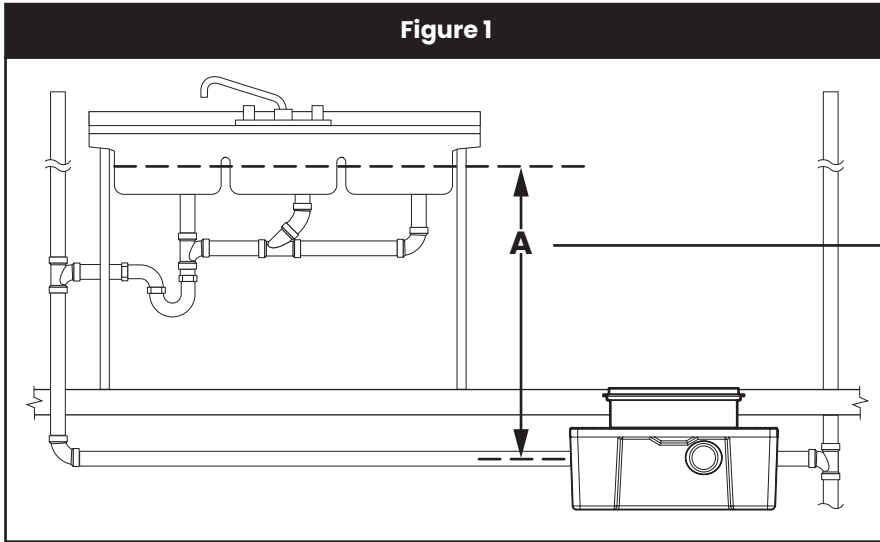

Note to Plumbing Inspector This interceptor includes certified internal flow control and does not require a dedicated "Flow Control Vent" (air intake).

- If dimension **A** is 5 feet or less **go to Step 4**.
- If dimension **A** is greater than 5 feet **follow Steps below**.

3a1 Rotate flow control cartridge counter-clockwise to release and remove from inlet diffuser

3a2

3b Depending on which flow rate is desired, attach either the 50 or 75 GPM Flow Control Cartridge Extension using PVC primer/cement. **Make sure extension is fully inserted into the cartridge and hold both components firmly together (until cement grabs) to prevent push-out.**

3c1

3c2 Slide flow control cartridge into top of inlet diffuser and rotate clockwise until cartridge drops onto flow control retainer pins. Continue rotating clockwise until pins are fully seated.

3d **OPTIONAL:** For easy flow control removal in deep burial installations, 1-1/2" PVC SCH. 40 pipe may be used as an extension handle. Before risers have been installed, cut pipe to length and attach to top of flow control cartridge using PVC primer/cement.

4 Excavation

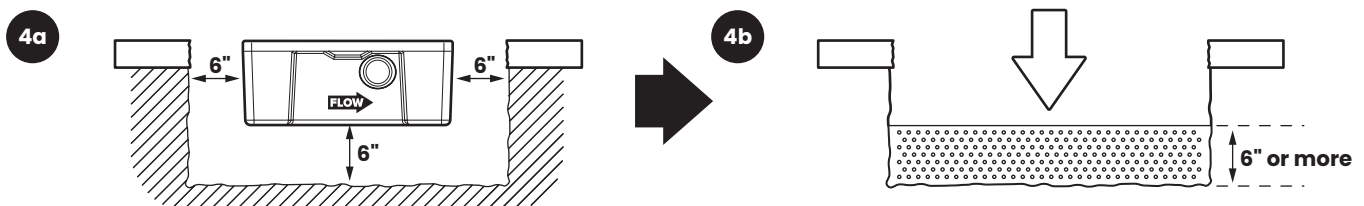

BURIED INSTALLATION

5 Connect Piping

! Floor Sink Installation

If your dishwashing sink(s) discharges into a floor drain/sink (drain), you must regulate the flow into the drain to avoid an overflow of water onto the kitchen floor. This can be done by installing a valve or flow restriction cap on the sink piping that discharges into the drain.

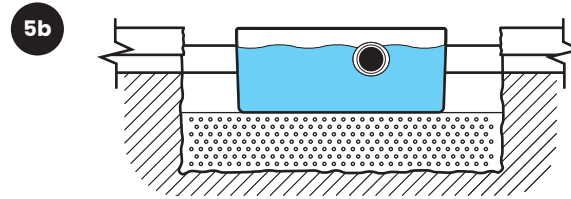
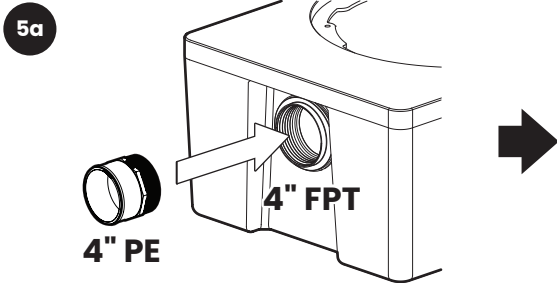
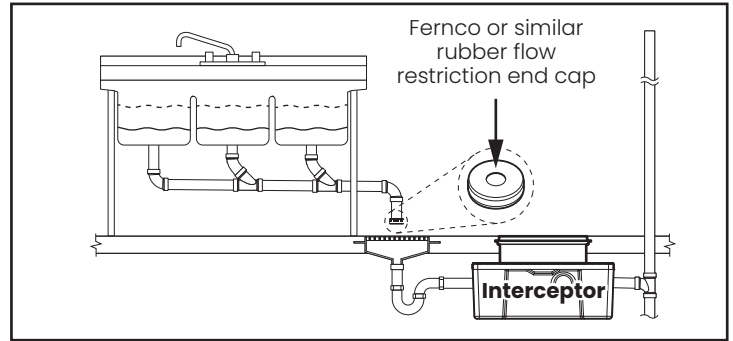

Set interceptor and connect piping using pipe thread sealant or tape approved for use with plastics. **Vent per local code.** Fill tank with water so that it remains in place during backfill.

Choose inlet and outlet fittings (included) based on pipe size.

6 Wet or Air Test Piping Per Local Code

! WARNING! DO NOT AIR TEST UNIT OR RISER SYSTEM!
Doing so may result in property damage, personal injury or death.



Leak? Call customer care at 913-951-3300
8a – 5p M – F CST

7 Backfill and Finished Grade

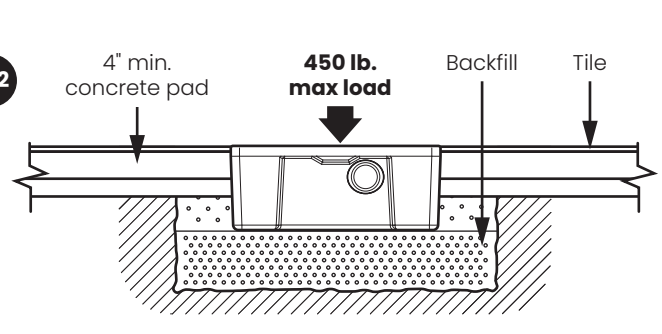
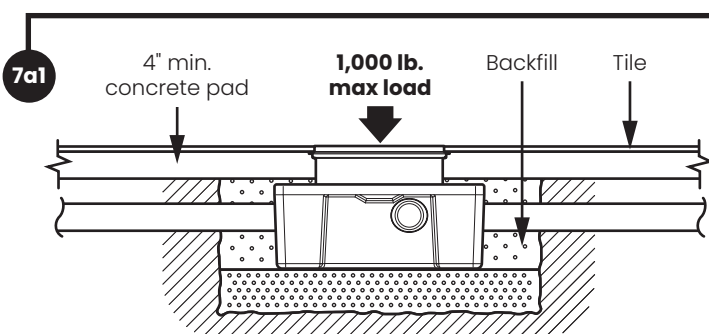

Below Grade with Riser (preferred): See instructions included with FCRI riser. Backfill evenly around tank using crushed aggregate (approximately 3/4" size rock or sand, with no fines), finish with a minimum 4" thick concrete pad.

Flush-to-Grade Burials:

! WARNING! Not recommended for heavy foot traffic areas without the use of an internal support system **SGK3** (sold additionally). Contact Customer Care for more details. Backfill evenly around tank using crushed aggregate (approximately 3/4" size rock or sand, with no fines), finish with a minimum 4" thick concrete pad.