

SECTION A-A

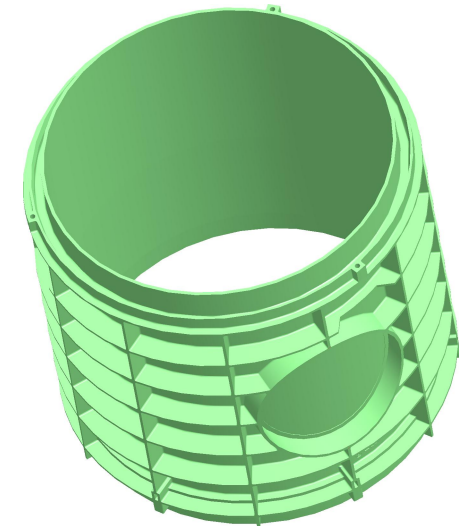

Material: Copolymer Polypropylene
Color: Green

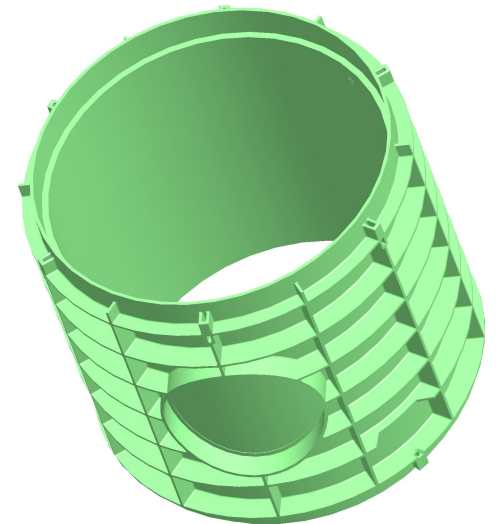
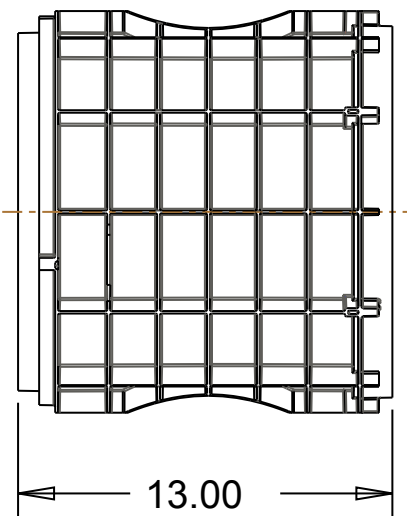
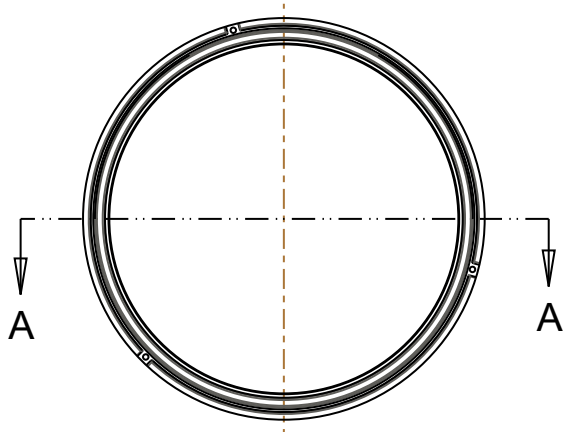

Drainage and Septic Products

Tuf-Tite, Inc.
1200 Flex Court
Lake Zurich, Illinois 60047

TELEPHONE: 847.550.1011
TOLL FREE: 800.382.7009
FAX: 847.550.8004

PART NAME: 12 X 12 RISER

PART #: 12 X 12 - RIS - GREEN